

C0138001/04-2022

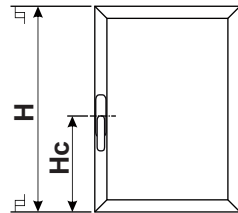

H ≥ 520
Hc ≥ 260

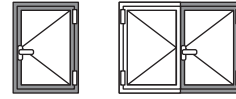
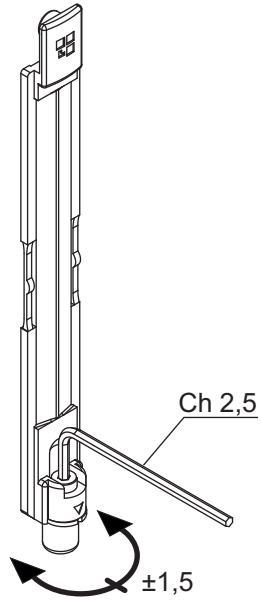
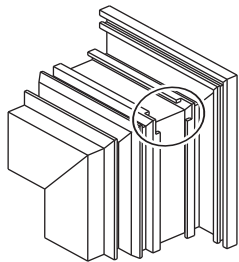
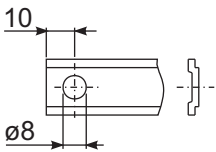
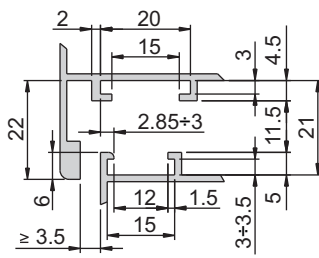
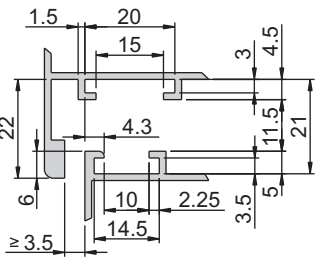
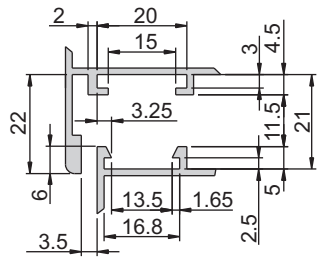
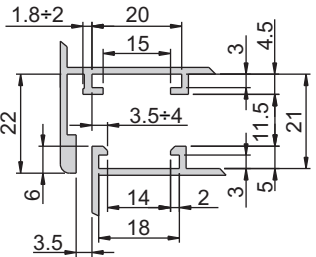
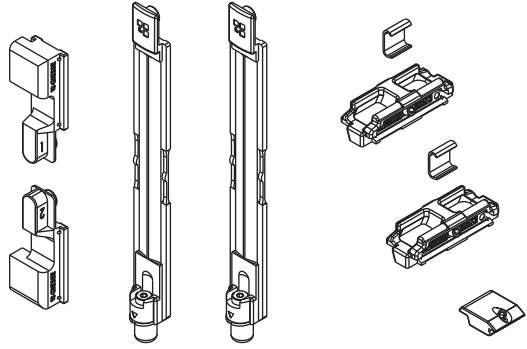