

107320000QNI/01-2016

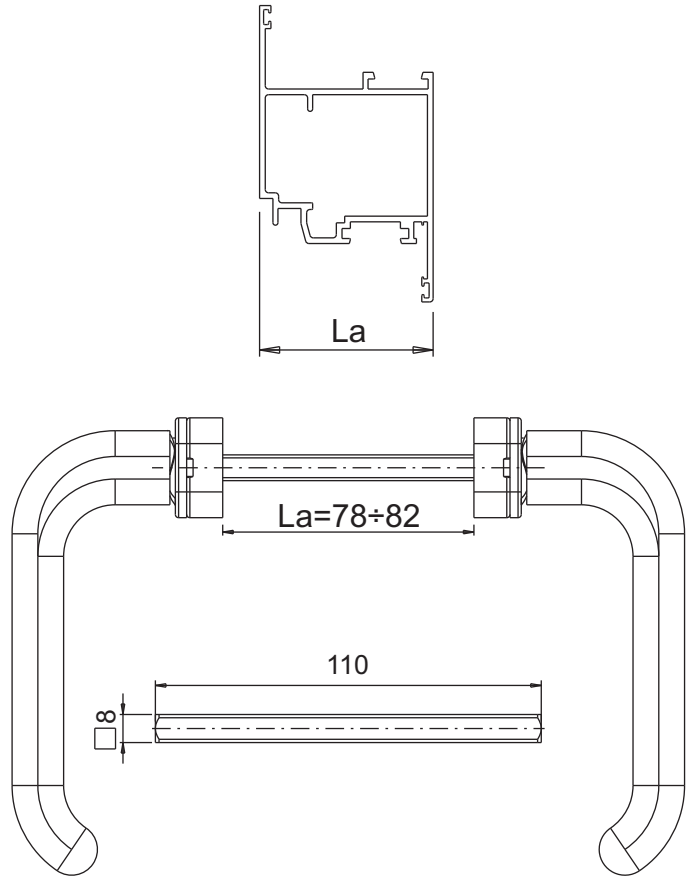

OPTIONAL

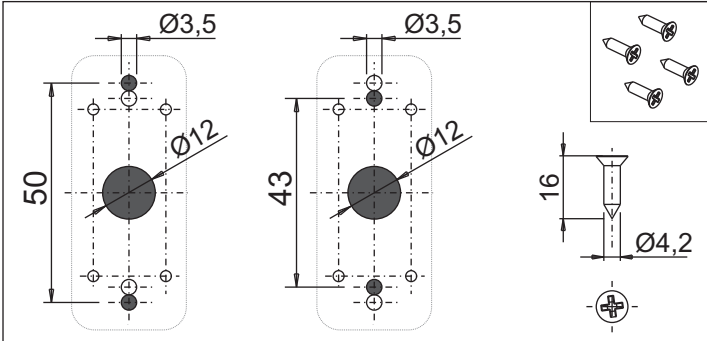
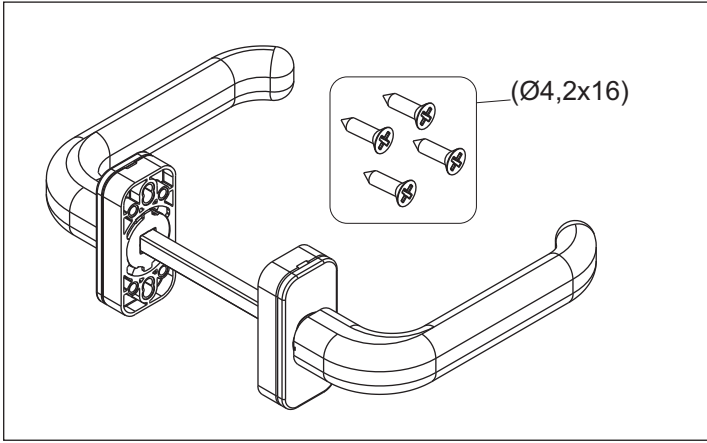
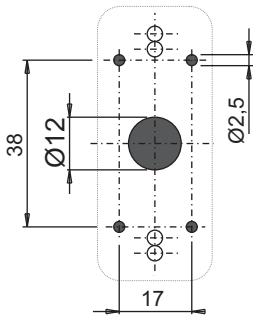

NON IN DOTAZIONE
NOT IN EQUIPMENT
NON FOURNIS
NO EN DOTACIÓN
NICHT ENTHALTEN

