

VERRIEGELUNGSBOLZEN

Funktion

Verriegelungsbolzen für den Einsatz mit Schließplatte zur Installation von zusätzlichen Schließstellen.

Technisches Online-Datenblatt

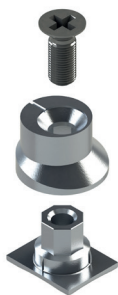

01319K

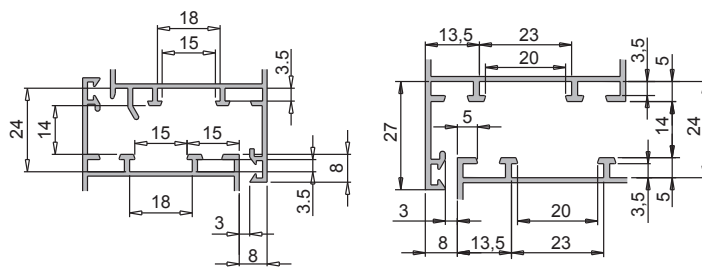
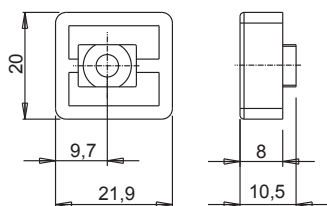
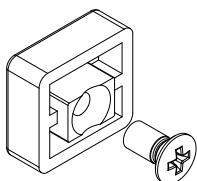

A= Zapfen B= Schließteil

01332

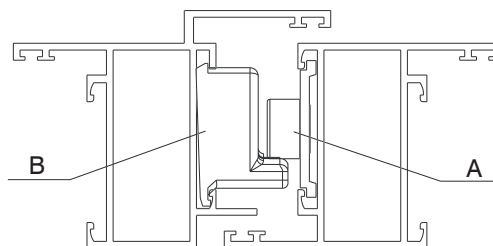
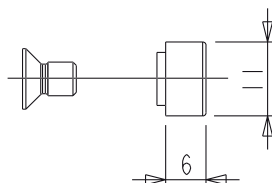
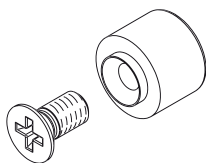

01333

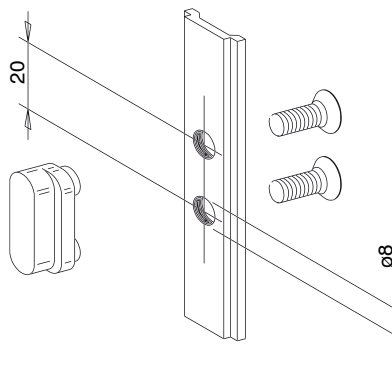
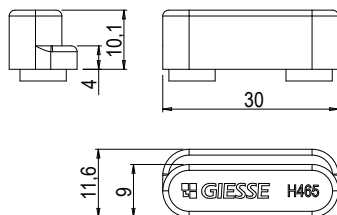
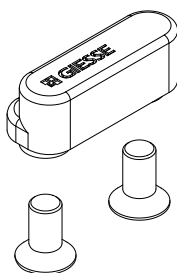

01352K

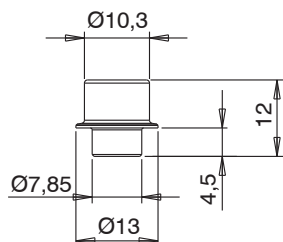
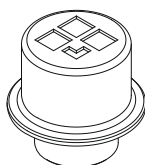

SCHLISSPLATTEN UND SCHLIESSELEMENTE

01356K

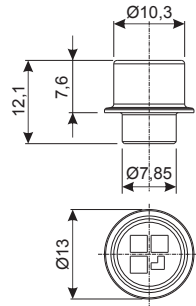

02315K

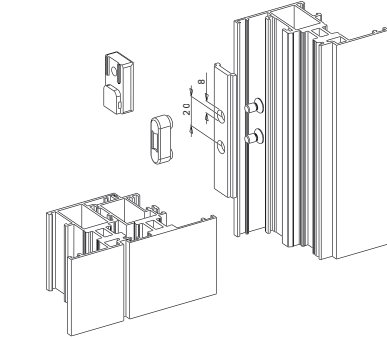
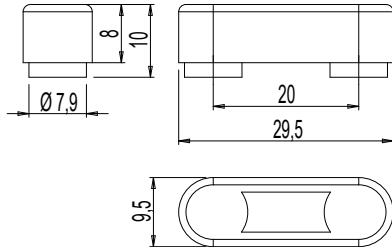
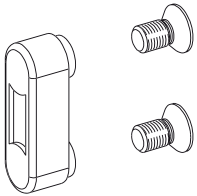

02320

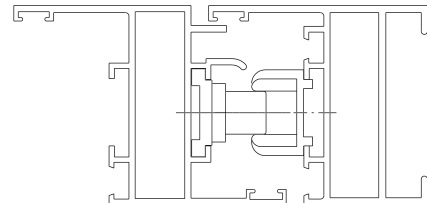
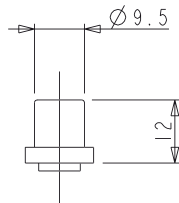
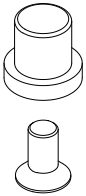

04027K

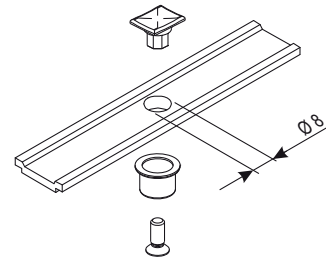
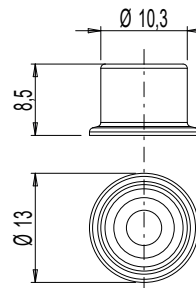

04030K

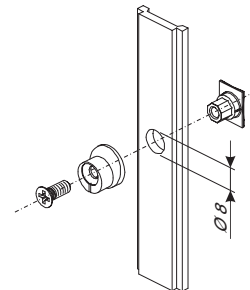
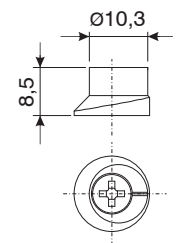
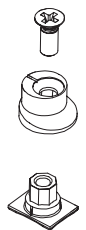

04042K

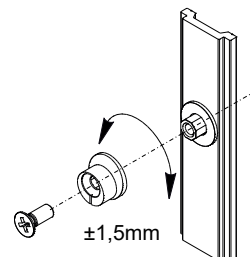
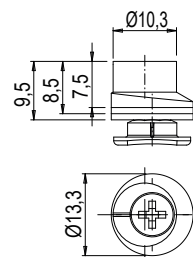
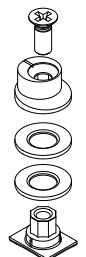

04049

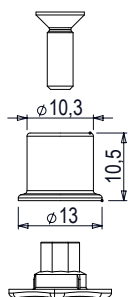

04050

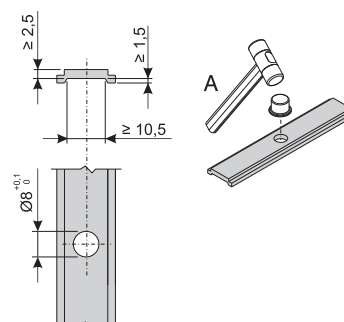
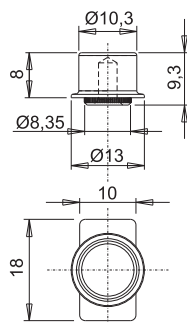
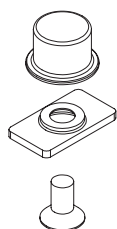

04067

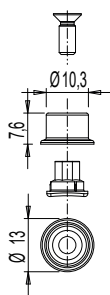
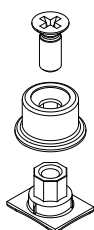

Art. Nr.	Einzelteilbezeichnung	QUERSCHNITT	Basis Neutral	Eloxiertes Elox	Lackiert	Trend/Gold Messing	Stücke pro Schachtel
01319K	SCHLIESSPLATTE 3. VERSCHLUSS	C007-C008	X				200
01332	ZAPFEN FÜR ZUSATZVERSCHLÜSSE		X				50
01333	ELEMENT FÜR ZUSATZVERSCHLÜSSE	C001-C002-C003-C004-C005-C006-C007-C008-C009-C010-C011-C012-C013-C014-C015-C016-C017	X				50
01352K	SCHLIESSZAPFEN	C001-C002-C003-C004-C005-C006-C007-C008-C009-C010-C011-C012-C013-C014-C015-C016-C017-P001-P002-P003-P004-P005-P006-P007-P008-P009-P010	X				400
01356K	ZUSÄTZLICHER VERRIEGELUNGSBOLZEN	C001-C002-C003-C004-C005-C006-C007-C008-C009-C010-C011-C012-C013-C014-C015-C016-C017-P001-P002-P003-P004-P005-P006-P007-P008-P009-P010	X				400
02315K	ELEMENT FÜR ZUSATZVERSCHLÜSSE		X				500
02320	ZAPFEN FÜR ZUSATZVERSCHLÜSSE		X				500
04027K	FIXER VERRIEGELUNGSBOLZEN FUTURA	C001-C002-C003-C004-C005-C006-C007-C008-C009-C010-C011-C012-C013-C014-C015-C016-C017-P001-P002-P003-P004-P005-P006-P007-P008-P009-P010	X				200
04030K	VERSTELLBARE SPERRKLINKE	C001-C002-C003-C004-C005-C006-C007-C008-C009-C010-C011-C012-C013-C014-C015-C016-C017-P001-P002-P003-P004-P005-P006-P007-P008-P009-P010	X				200
04042K	VERSTELLBARE SPERRKLINKE	C001-C002-C003-C004-C005-C006-C007-C008-C009-C010-C011-C012-C013-C014-C015-C016-C017-P001-P002-P003-P004-P005-P006-P007-P008-P009-P010	X				200
04049	FIXER VERRIEGELUNGSBOLZEN		X				200
04050	FIXER VERRIEGELUNGSBOLZEN	C001-C002-C003-C004-C005-C006-C007-C008-C009-C010-C011-C012-C013-C014-C015-C016-C017-P001-P002-P003-P004-P005-P006-P007-P008-P009-P010	X				200
04067	FIXER VERRIEGELUNGSBOLZEN FUTURA	C001-C002-C003-C004-C005-C006-C011-C012-C013-C014-C015-C016-C017-P001-P002-P003-P004-P005-P006-P007-P008-P009-P010	X				200