

EURO AWAY CREMONE

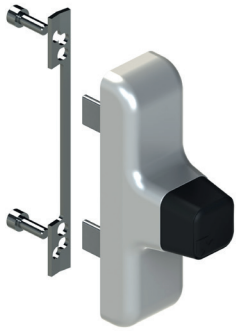

Functions

Reversible cremone handle for operating the GIESSE Sash and Tilt-and-Turn Window mechanisms. Enables operating casements and removing the handle for security requirements.

Online data sheet



Technical Features

The use of high quality die-cast materials and the GIESSE painting system guarantee excellent mechanical performance, together with colour uniformity and good abrasion resistance.

Depending on the version, they are available with snap positioning of the pull handle at 0°, 90° and 180°.

The EURO AWAY cremone, supplied right-handed, has fixing C/C distance of 104 mm (for alternative C/C distance see the table).

Available in both one-way and two-way versions.

For use in combination with the adjustable pull handle art. 01130.

Materials

Cremone case, gear

Racks and die-cast zamak sliders

Internal sheath and Hostaform plate

Stainless steel screws and fixing plate

Away turret and cap in black polyamide

Parts

1 fixing plate

2 HSHC screws M5x14

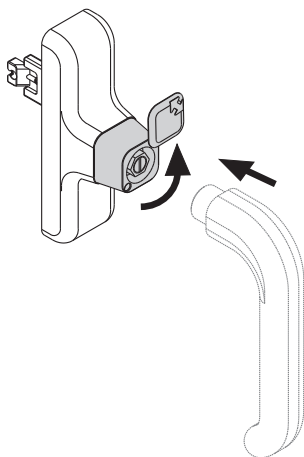

C/C distance machining 104 mm

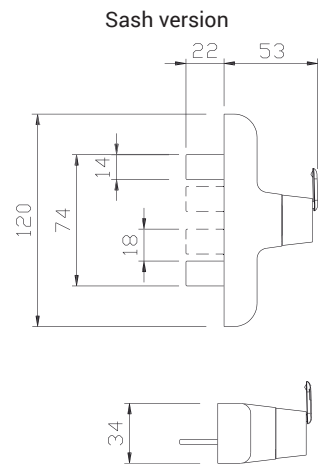
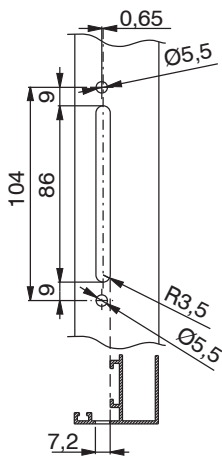

C/C distance machining 84.5 mm

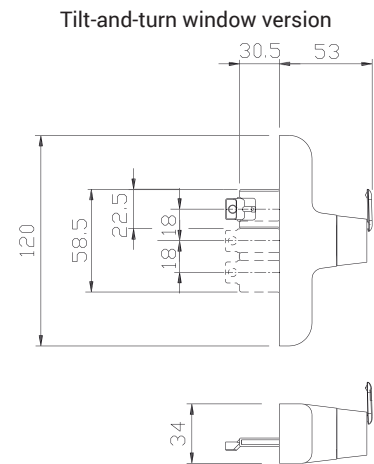
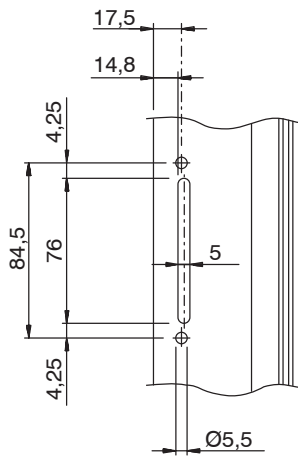

C/C distance machining 98 mm

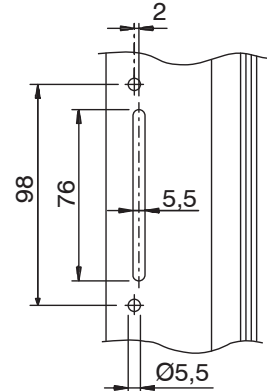

Item code	Description	PROFILE CROSS - SECTION	Version	C/C distances	Operation	Pull handle 0°	Pull handle 90°	Pull handle 180°	Base Raw	Anodised Elox	Painted	Trend/Gold Brass	Pieces per pack
01001	EURO AWAY CREMONE	C001-C002-C003-C004-C005-C006-C007-C008-C009-C010-C012-C013-C014-C015-C016-C017-P001-P002-P004-P005-P006-P007-P008-P009-P010	Sash	104 - 98 - 84	Two-way	Closed	Open	-	X		X		5
01091K	EURO AWAY CREMONE	C001-C002-C003-C004-C005-C006-C007-C008-C009-C010-C012-C013-C014-C015-C016-C017	Tilt-and-turn window	104 - 98 - 84	One-way	Closed	Open	Bottom-hung windows	X		X		5
01130	EURO REMOVABLE PULL HANDLE	C001-C002-C003-C004-C005-C006-C007-C008-C009-C010-C012-C013-C014-C015-C016-C017-P001-P002-P004-P005-P006-P007-P008-P009-P010	-	-	-	-	-	-	X				1