



## BRIO EVO HANDLE

### Functions

Reversible recessed handle, with the possibility of manual mode operation (for door) or automatic operation (for window), to enable side locking of sliding sashes.

Online data sheet



### Technical Features

The Brio Evo handle allows crossing and overlapping of the two sashes and it is fixed to the profile quickly and precisely by inserting the bottom part of the handle in the slot and then pressing down the top part.

After determining the optimum position of the nib (and therefore locking), it is secured with a grub screw, located under the covering cap.

The polyamide slider has two green and red surfaces that indicate respectively sash open and sash closed.

The Brio Evo handle is fitted with an antilifting system to ensure that the casement can only be opened by moving the small polyamide recess handle on the interior.

The product is preset as standard for automatic operation (for window); for manual mode operation (for door) the pre-assembled spring on the product must be eliminated. The screw supplied must be screwed onto the nib carrier if the handle has to perform the burglar-proof function in manual mode operation.

The product is available in two different styles: rounded design and square design. Each style is available with 2-teeth or 1-tooth spring fixing, a solution to be chosen based on the type of sash profile used.

### Materials

Body in extruded aluminium

Slider in white die-cast zinc plated Zamak

Polyamide recess handle

Stainless steel grub screw

Harmonic steel spring for automatic operation

Bottom fixing spring in C70 Geomet steel

### Parts

1 screw for burglar-proof function

0299202

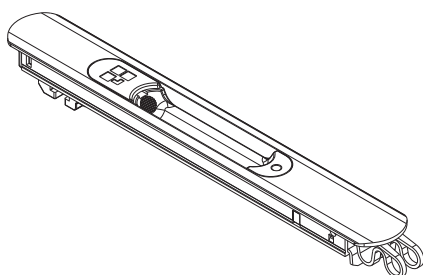

06004

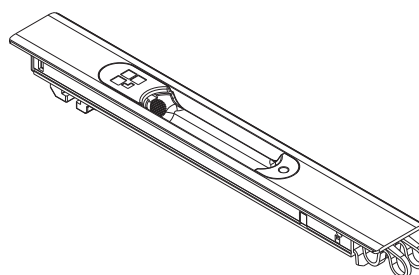

0298201

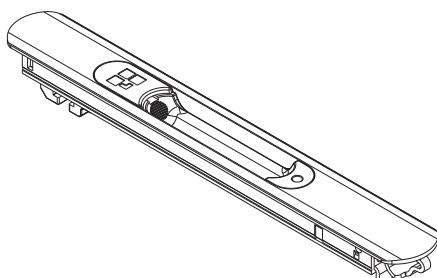

06006

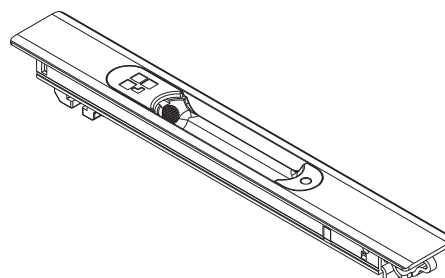

# RECESSED HANDLES

Machining on profile

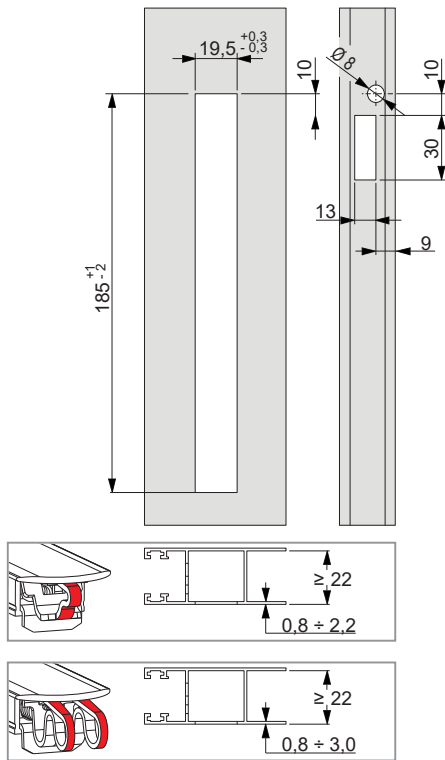

A: 2-teeth spring - B: 1-tooth spring

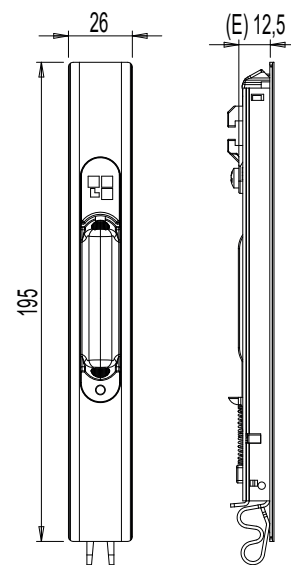
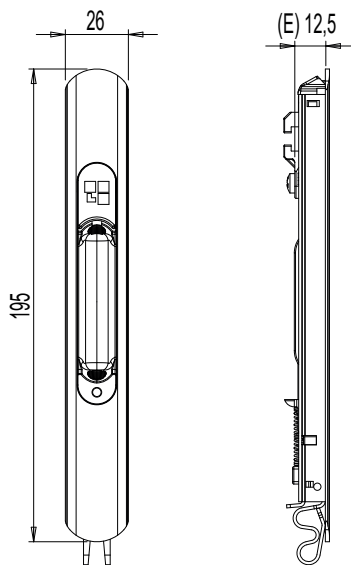
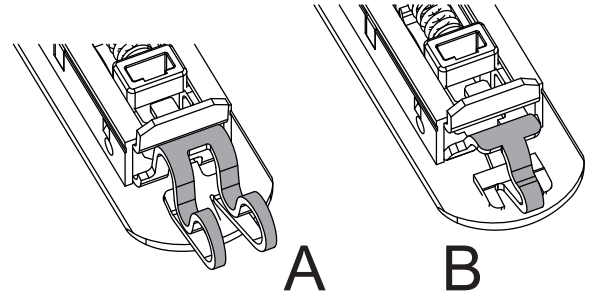

Item code	Description	Design	Backset E [mm]	Fixing spring	Matching handles (Inside)	Matching handles (Outside)	Base Raw	Anodised Elox	Painted	Trend/Gold Brass	Pieces per pack
0298201	BRIO EVO MD HANDLE	Rounded	12,5	1-tooth (B)	03043 - 03050 - 03064	02966N - 02967V - 02996	X		X		20
0299202	BRIO EVO HANDLE	Rounded	12,5	2 teeth (A)	03043 - 03050 - 03064	02966N - 02967V - 02996	X	X	X	X	20
06004	BRIO EVO HANDLE	Square	12,5	2 teeth (A)	03043 - 03050 - 03064	-	X		X	X	20
06006	BRIO EVO MD HANDLE	Square	12,5	1-tooth (B)	03043 - 03050 - 03064	-	X		X	X	20