

**DUST-PROOF PLUG**

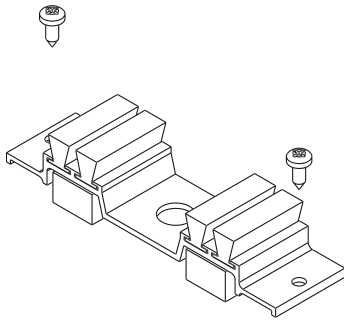

**Functions**

Component designed to prevent dust and water passing into the interior of the sliding door/window.

Online data sheet



**Technical features**

The dust cap fits to the upper and lower cross beams of the fixed frame using self-tapping screws.

The sponge fits snugly against the sash to prevent dust and water entering.

**Materials**

Black anodised extruded aluminium body

Zinc plated steel screws

Brushes and sponge in expanded EPDM

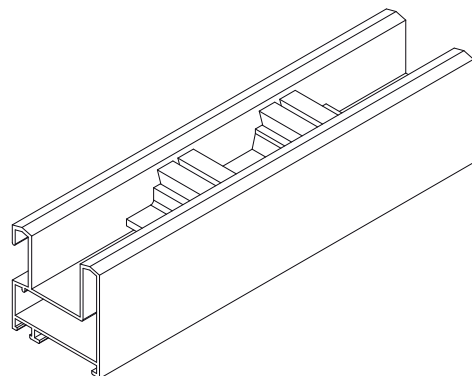
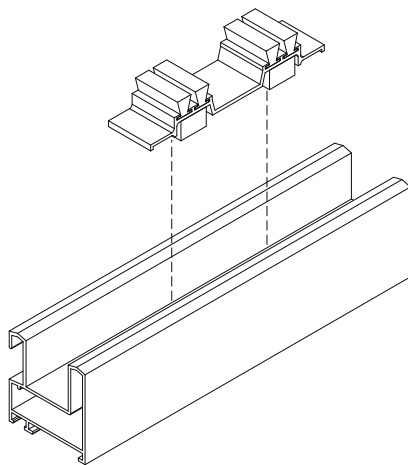
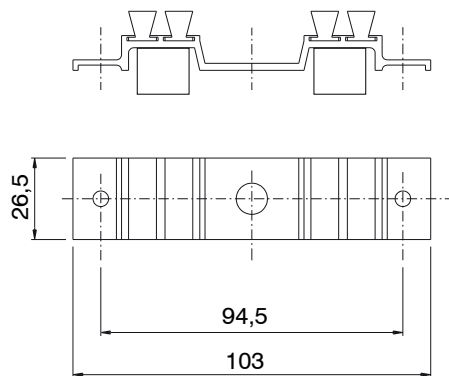

Item code	Description	Note	Base Raw	Anodised Elox	Painted	Trend/Gold Brass	Pieces per pack
02304	DUST-PROOF PLUG		X				100