

CASQUILLOS



Funciones

Elemento que se instala a presión en la base de una ventana o puerta corredera de aluminio para la evacuación del agua.

Materiales

Poliamida negra

Ficha técnica on-line



02367

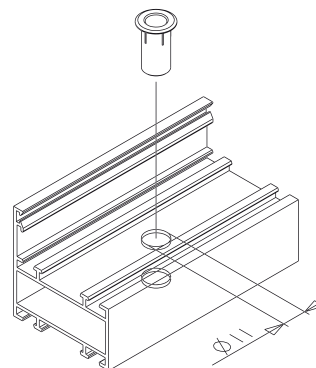
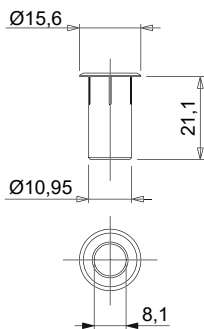
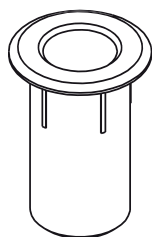

03156

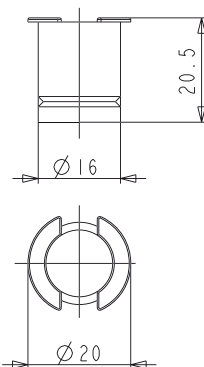
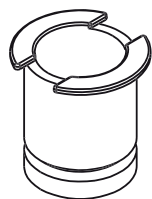

03196

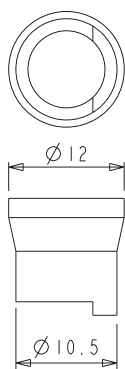
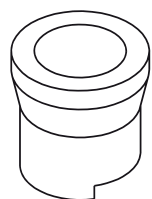

Durante el montaje, algunas series requieren quitar la parte terminal a nivel de la línea de fractura establecida.



Código	Descripción	Nota	Base Bruto	Anodizado Elox	Lacado	Trend/Oro Latón	Unidades por conexión
02367	CASQUILLO DRENAJE ALFÉIZAR		X				500
03156	CASQUILLO TUBO DE DESAGÜE		X				100
03196	CASQUILLO TUBO DE DESAGÜE		X				100