

## BULONES

### Funciones

Bulón fijo que se combina con un tope para realizar un punto de cierre.

Ficha técnica on-line

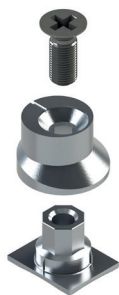

01319K

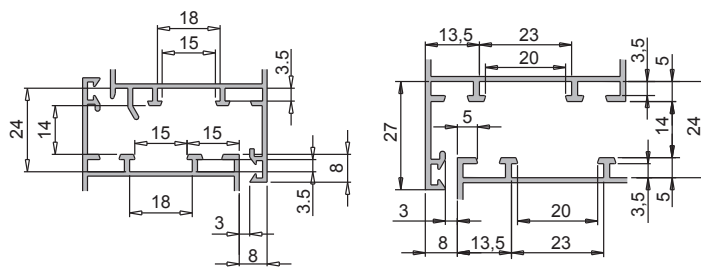
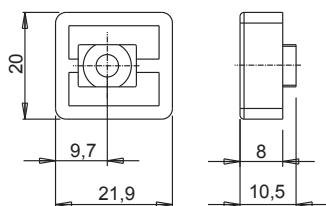
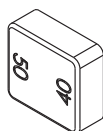
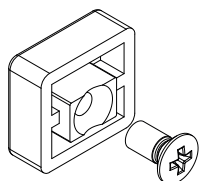

A= perno B= encuentro

01332

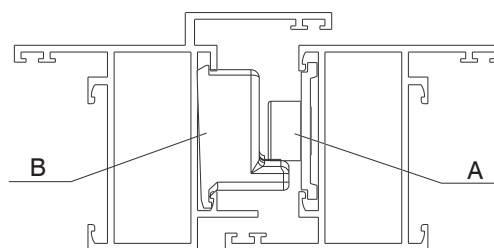
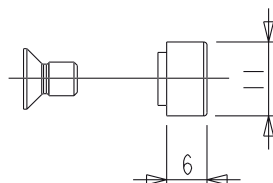
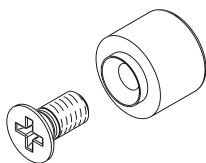

01333

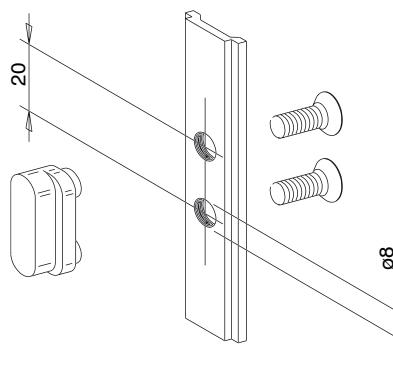
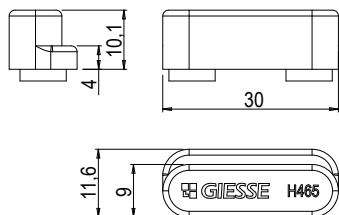
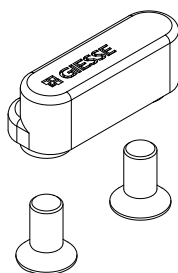

01352K

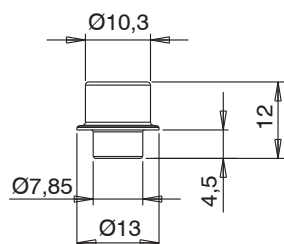
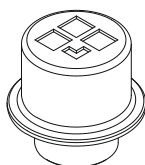

01356K

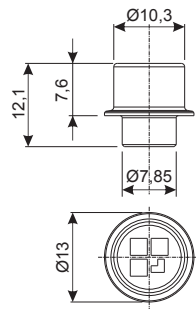

02315K

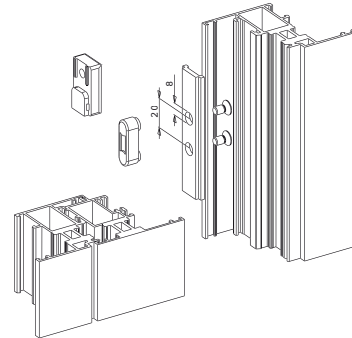
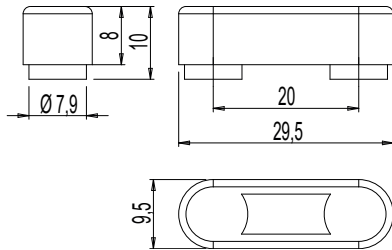
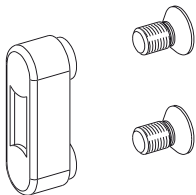

02320

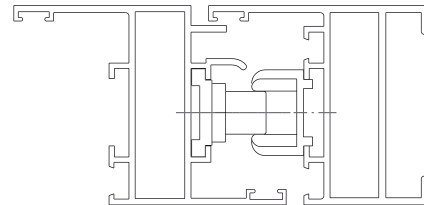
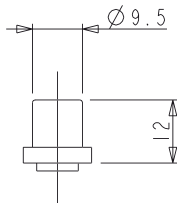
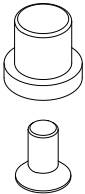

04027K

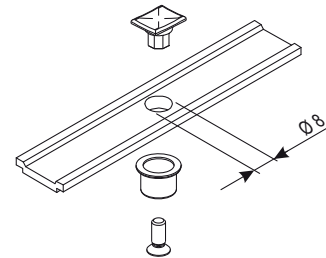
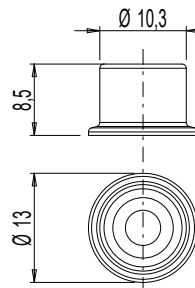

04030K

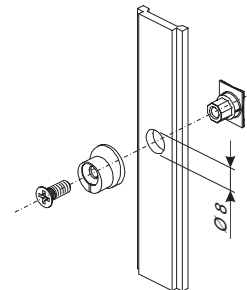
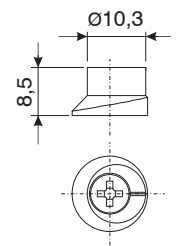

04042K

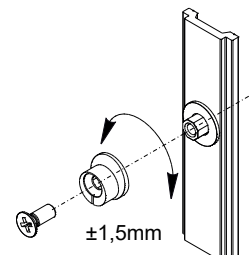
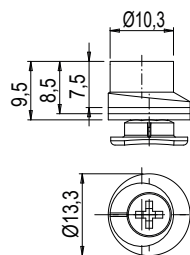
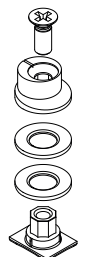

04049

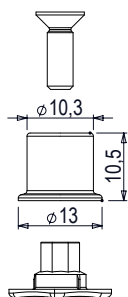

04050

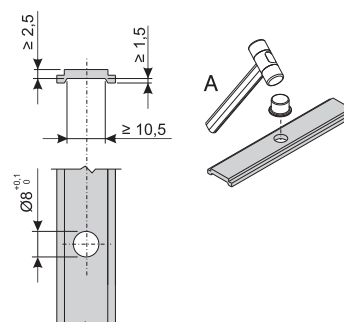
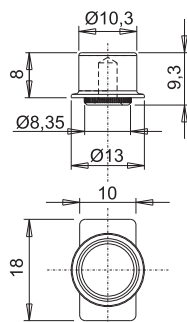
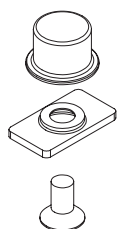

04067

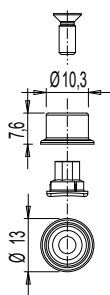
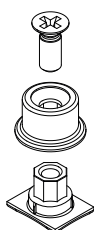

Código	Descripción	NUDO	Base Bruto	Anodizado Elox	Lacado	Trend/Oro Latón	Unidades por confección
01319K	ENCUENTRO 3° CIERRE	C007-C008	X				200
01332	PERNO PARA CIERRES ADICIONALES		X				50
01333	ELEMENTO PARA CIERRES ADICIONALES	C001-C002-C003-C004-C005-C006-C007-C008-C009-C010-C011-C012-C013-C014-C015-C016-C017	X				50
01352K	BULON DE CIERRE	C001-C002-C003-C004-C005-C006-C007-C008-C009-C010-C011-C012-C013-C014-C015-C016-C017-P001-P002-P003-P004-P005-P006-P007-P008-P009-P010	X				400
01356K	BULÓN ADICIONAL	C001-C002-C003-C004-C005-C006-C007-C008-C009-C010-C011-C012-C013-C014-C015-C016-C017-P001-P002-P003-P004-P005-P006-P007-P008-P009-P010	X				400
02315K	ELEMENTO PARA CIERRES ADICIONALES		X				500
02320	PERNO PARA CIERRES ADICIONALES		X				500
04027K	BULON FIJO FUTURA	C001-C002-C003-C004-C005-C006-C007-C008-C009-C010-C011-C012-C013-C014-C015-C016-C017-P001-P002-P003-P004-P005-P006-P007-P008-P009-P010	X				200
04030K	BULON REGULABLE DE CIERRE	C001-C002-C003-C004-C005-C006-C007-C008-C009-C010-C011-C012-C013-C014-C015-C016-C017-P001-P002-P003-P004-P005-P006-P007-P008-P009-P010	X				200
04042K	BULON REGULABLE DE CIERRE	C001-C002-C003-C004-C005-C006-C007-C008-C009-C010-C011-C012-C013-C014-C015-C016-C017-P001-P002-P003-P004-P005-P006-P007-P008-P009-P010	X				200
04049	BULÓN FIJO		X				200
04050	BULÓN FIJO	C001-C002-C003-C004-C005-C006-C007-C008-C009-C010-C011-C012-C013-C014-C015-C016-C017-P001-P002-P003-P004-P005-P006-P007-P008-P009-P010	X				200
04067	BULON FIJO FUTURA	C001-C002-C003-C004-C005-C006-C011-C012-C013-C014-C015-C016-C017-P001-P002-P003-P004-P005-P006-P007-P008-P009-P010	X				200