

POINTS DE FERMETURE

Fonctions

Bague de réglage à associer à une gâche, nécessaire pour la réalisation d'un point de fermeture.

Fiche technique en ligne



01319K

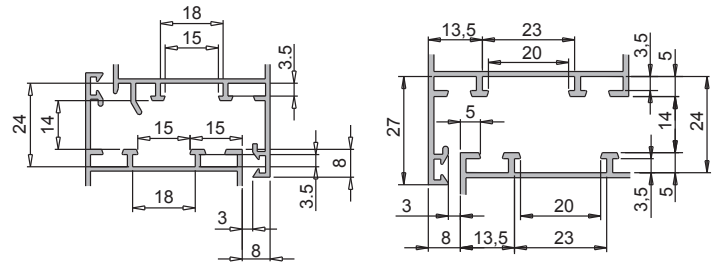
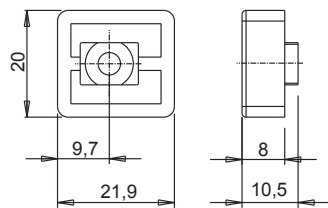
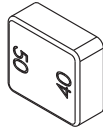
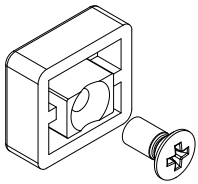

A= embout B= gâche

01332

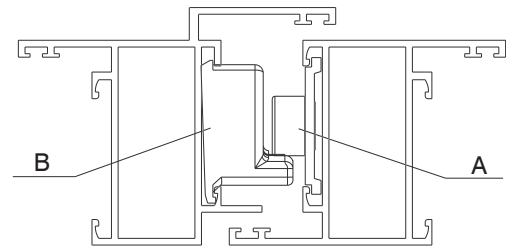
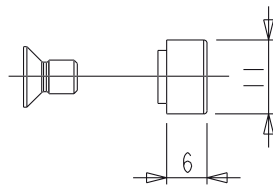
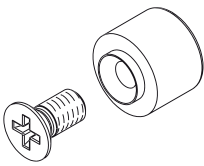

01333

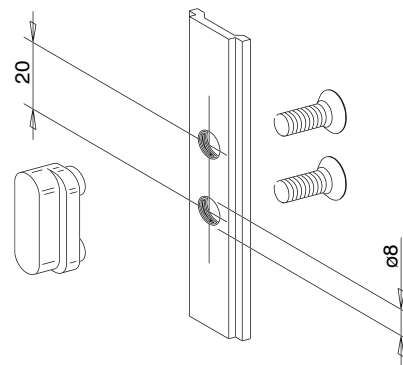
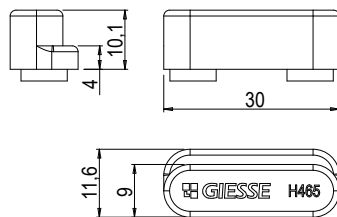
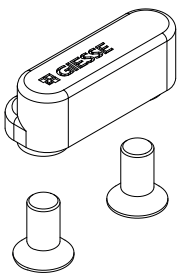

01352K

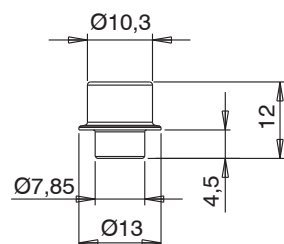
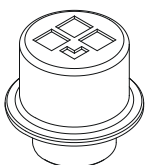

GÂCHES ET ÉLÉMENTS DE FERMETURE

01356K

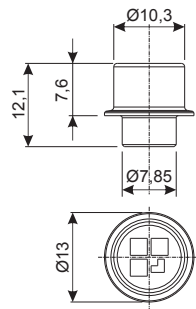

02315K

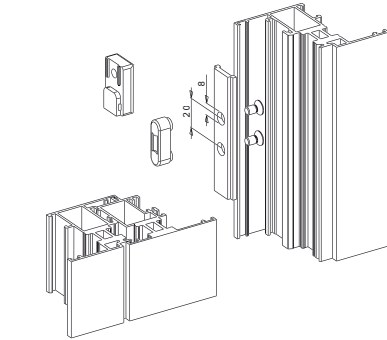
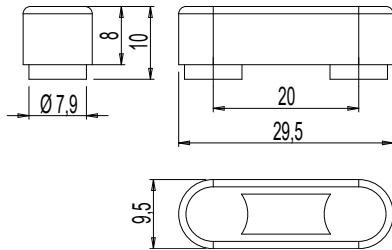
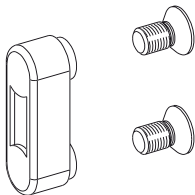

02320

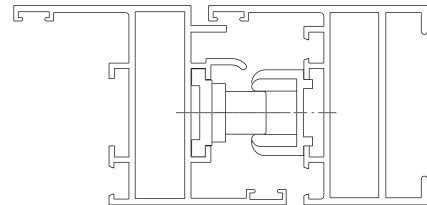
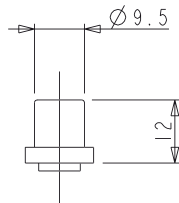
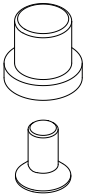

04027K

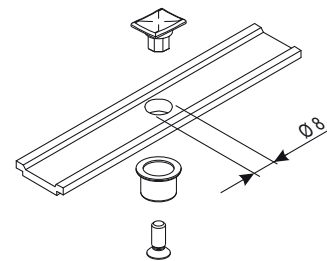
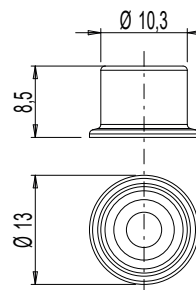

04030K

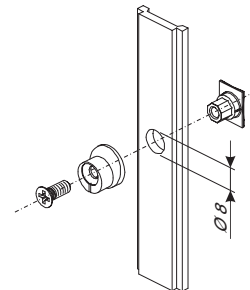
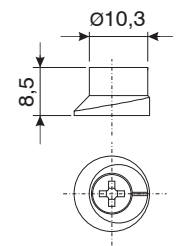
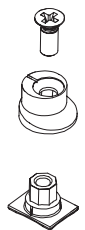

04042K

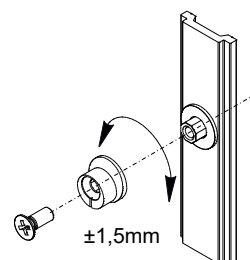
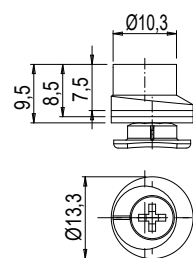
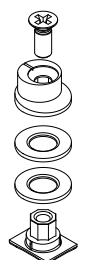

04049

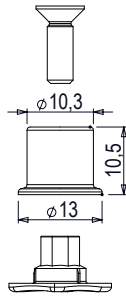

04050

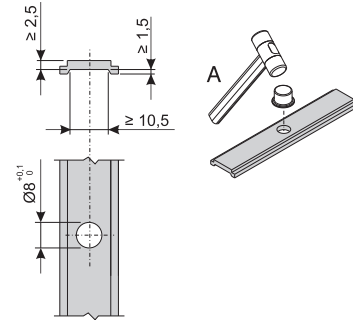
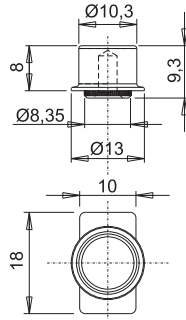
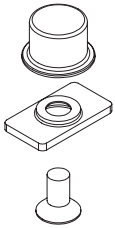

04067

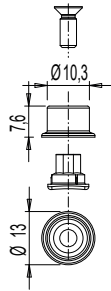
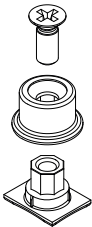

Référence article	Description	GORGE	Brut	Anodisé Elox	Laqué	Trend/Or Laiton	Pièces par boîte
01319K	GÂCHE 3e FERMETURE	C007-C008	X				200
01332	AXE POUR FERMETURES SUPPLÉMENTAIRES		X				50
01333	ÉLÉMENT POUR FERMETURES SUPPLÉMENTAIRES	C001-C002-C003-C004-C005-C006-C007-C008-C009-C010-C011-C012-C013-C014-C015-C016-C017	X				50
01352K	POINT DE FERMETURE	C001-C002-C003-C004-C005-C006-C007-C008-C009-C010-C011-C012-C013-C014-C015-C016-C017-P001-P002-P003-P004-P005-P006-P007-P008-P009-P010	X				400
01356K	POINT DE FERMETURE SUPPLÉMENTAIRE	C001-C002-C003-C004-C005-C006-C007-C008-C009-C010-C011-C012-C013-C014-C015-C016-C017-P001-P002-P003-P004-P005-P006-P007-P008-P009-P010	X				400
02315K	ÉLÉMENT POUR FERMETURES SUPPLÉMENTAIRES		X				500
02320	AXE POUR FERMETURES SUPPLÉMENTAIRES		X				500
04027K	POINT DE FERMETURE FIXE	C001-C002-C003-C004-C005-C006-C007-C008-C009-C010-C011-C012-C013-C014-C015-C016-C017-P001-P002-P003-P004-P005-P006-P007-P008-P009-P010	X				200
04030K	POINT DE FERMETURE RÉGLABLE	C001-C002-C003-C004-C005-C006-C007-C008-C009-C010-C011-C012-C013-C014-C015-C016-C017-P001-P002-P003-P004-P005-P006-P007-P008-P009-P010	X				200
04042K	POINT DE FERMETURE RÉGLABLE	C001-C002-C003-C004-C005-C006-C007-C008-C009-C010-C011-C012-C013-C014-C015-C016-C017-P001-P002-P003-P004-P005-P006-P007-P008-P009-P010	X				200
04049	PLOT FIXE		X				200
04050	PLOT FIXE	C001-C002-C003-C004-C005-C006-C007-C008-C009-C010-C011-C012-C013-C014-C015-C016-C017-P001-P002-P003-P004-P005-P006-P007-P008-P009-P010	X				200
04067	POINT DE FERMETURE FIXE	C001-C002-C003-C004-C005-C006-C011-C012-C013-C014-C015-C016-C017-P001-P002-P003-P004-P005-P006-P007-P008-P009-P010	X				200