

# QL 3074

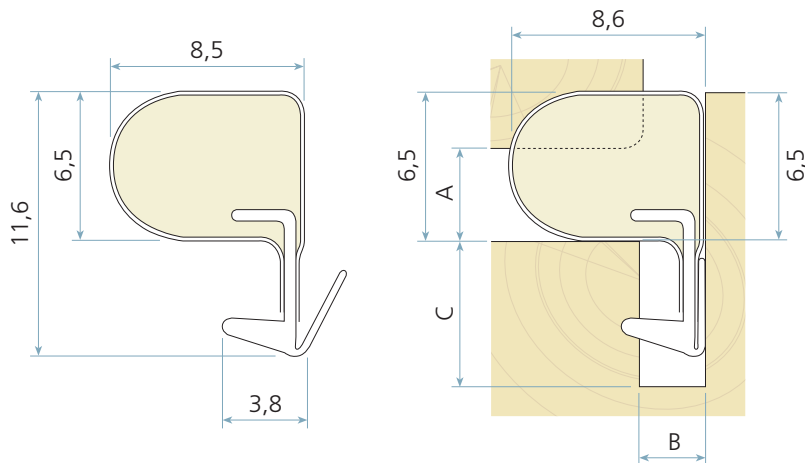

## Technical specification

- A Seal gap: 3,5 mm minimum to 5,5 mm maximum
  - B Groove width: 2,7 – 3,2 mm nominal
  - C Minimum groove depth: 6,5 mm
- Rebate dimension: 8,5 mm

## Colours

- White (≈ RAL 9003)
  - Black (≈ RAL 9005)
  - Bronze (≈ RAL 8019)
  - Silver grey (≈ RAL 7001)
- Other colours upon request

## Packaging

- 300 m x 2

## Coil direction

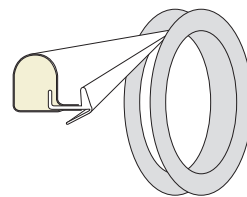

## Schlegel Acquisition Holdings Limited trading as Schlegel International

Unit 25, Henlow Industrial Estate, Henlow Camp, Bedfordshire, SG16 6DS United Kingdom

All dimensions are in mm and are nominal. Schlegel reserve the right to change specification without prior notice.

Schlegel's names and logos and all related trademarks (including 'SCHLEGEL', 'SCHLEGEL Red Square Logo', 'Red Square Logo' and 'Q-Lon'), trade names, and other intellectual property are the property of Schlegel Acquisition Holdings Limited trading as Schlegel International and cannot be used without its express prior written permission. All rights reserved.

© Schlegel Acquisition Holdings Limited trading as Schlegel International 2015.