

TECHNICAL SPECIFICATION

A Seal gap: 4,0 mm minimum to 7,5 mm maximum

B Groove width: 3,5 – 4,0 mm nominal

C Minimum groove depth: 7,0 mm

Rebate dimension: 12,0 mm

PACKAGING

200 m x 2

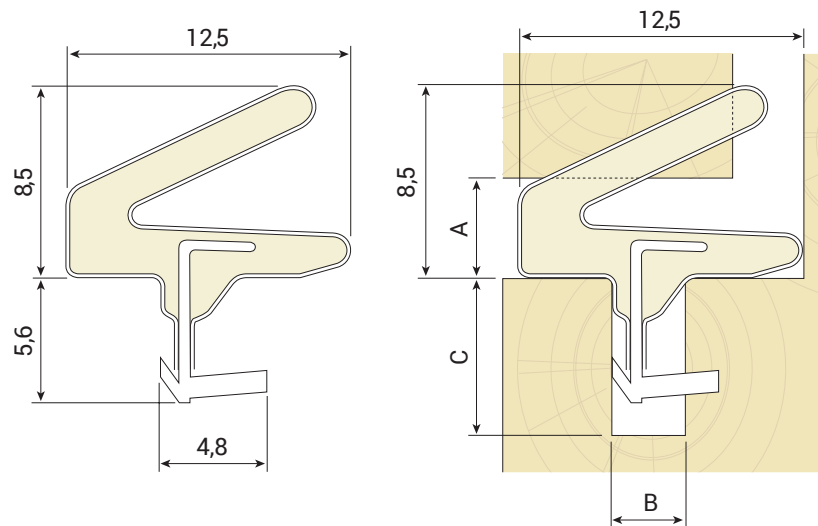

Coil direction

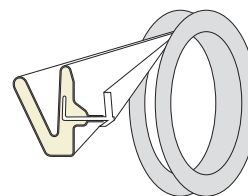

Colours (≈ RAL)			
7001	8019	9003	9005
Silver Grey	Brown	White	Black

Other colours upon request