

TECHNICAL SPECIFICATION

- A** Seal gap: 2,7 mm minimum to 4,6 mm maximum
- B** Retention slot throat: 4,6 mm nominal
- C** Minimum slot depth: 2,3 mm

PACKAGING

200 / 500 m x 2

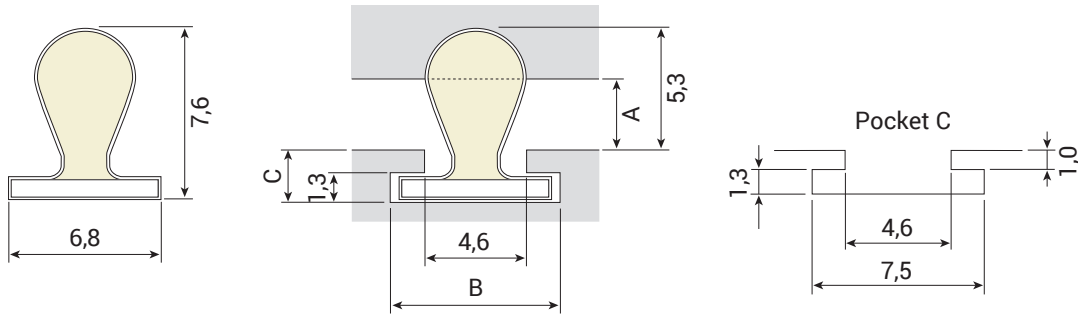

Coil direction

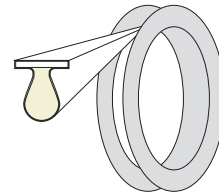

Colours (≈ RAL)

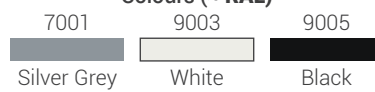

Other colours upon request