

A detailed, close-up photograph of a window's internal hardware, showing the frame, handle, and various mechanical components. The image is oriented vertically, with the window frame at the top and the handle at the bottom. The lighting highlights the metallic surfaces and the intricate design of the hardware.

HARDWARE USE AND MAINTENANCE MANUAL

General maintenance (cleaning) for the end user

Periodic cleaning of hardware	4
Safety guide	5
General safety instructions	6
Specific instructions for use by type of opening:	
Inward opening side-hung: tilt-and-turn window opening hardware	8
Inward opening side-hung: pivoting window opening hardware	9
Outward opening: outward opening hardware	9
Sliding opening: lift-and-slide hardware	10
Sliding opening: sliding hardware	10
Inward opening: tilt-and-slide hardware	11
Door Hardware	12

General maintenance for specialists

Periodic cleaning of hardware	13
Specific instructions for use by type of opening:	
Inward opening: tilt-and-turn window opening hardware	14
Inward opening: tilt-and-turn C.H.I.C. hardware	15
Inward opening: pivoting window opening hardware	16
Outward opening hardware	17
Sliding opening: lift-and-slide hardware	18
Sliding opening: sliding hardware	19
Inward opening: tilt-and-slide hardware	20
Door Hardware	21
Hardware maintenance frequency table	22

HARDWARE USE AND MAINTENANCE MANUAL

This manual illustrates the storage and maintenance criteria to be followed to ensure proper operation and to maintain the aesthetic requirements of Giesse hardware over time.

This manual is to be considered an integral part of the product and must be kept until disposal of the product. The manual must be kept in a suitable place known to all the people concerned so that it is always available for reference.

The installer must provide the user with the following USE AND MAINTENANCE document which the user must keep. If the hardware is not used in observance of the conditions stated in this manual, Giesse declines all liability for damage or physical injury.

Our service and support offices are at your disposal for any technical questions about this manual or any trouble and/or malfunctioning.

Periodic cleaning of hardware

Clean all the moving parts of the hardware and all the fastening mechanisms regularly. Do not use aggressive cleaning products as these may compromise the protective treatments of the hardware, simply use neutral soap and water.

All the hardware components have received a surface treatment to prevent them from corroding. Accelerated tests in special climatic chambers verify the performance of these treatments, but performance of surface treatments cannot be assured without regular preventative cleaning and treatment of surfaces.

The accumulation of contaminants on the components, combining with water, can ruin the surface finish.

To maintain the quality of the surface of the hardware over time and to prevent deterioration due to corrosion, it is essential to observe the following:

- ✓ The aggressive vapours in the cavity between frame and sash (due, e.g., to formic or acetic acid, ammonia, amine or ammonia compounds, aldehyde, phenol, tannic acid, etc.) in combination with condensation can cause rapid corrosion of the mechanisms. When there are these aggressive vapours, it is necessary to provide sufficient ventilation for the area of the rebate of windows and balcony-doors.
- ✓ Clean all exposed parts or surfaces to prevent dirt from being able to build up, especially for external hardware. In this way, you can remove any acid deposits from smog, acid rain, etc., preventing oxidation and corrosion of the parts and mechanisms for moving the sashes.

If there are any scratches or other damage on the surface, its protection against corrosion is no longer guaranteed, so be aware:

- ✓ Do not use any aggressive or corrosive cleaning products, solvents or detergents, such as synthetic thinners, acetone or nitro thinners; do not use any products whose makeup is unknown, and do not use any solvent based detergents and polishers.
- ✓ Refer to the product labels before use to ensure that they are compliant.
- ✓ Do not use any abrasive substances.
- ✓ Do not use any hard materials such as scrapers, metal brushes, rough sponges, etc.

In the case of sliding windows, clean the sash runners frequently, removing the dust, sand, salt, etc., which may hinder the smooth sliding of the pulleys.

For GOS-S windows, in order to enable excellent drainage of the water, periodically clean or vacuum the area by the T-REX water evacuation plug.

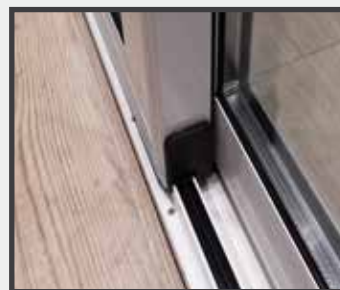
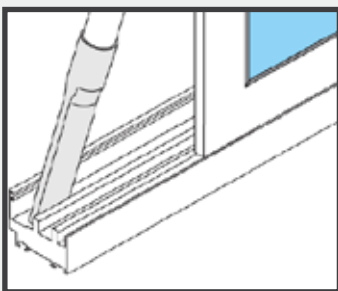

Safety guide

The hardware is of primary importance to the window or door set, proper use and maintenance of the hardware not only ensures that the set is easy to operate, but is also in the interests of user safety.

In this manual, safety information is indicated by a symbol. The safety information is introduced by a key word that indicates the severity of the danger.



DANGER!

This symbol in conjunction with the signal word indicates an imminently hazardous situation, which could result in death or serious damage to health if it is not avoided.



WARNING!

This symbol in conjunction with the signal word indicates a potentially dangerous situation, which could result in serious damage to health if it is not avoided.



CAUTION!

This symbol in conjunction with the signal word indicates a potentially dangerous situation, which may lead to minor or light injuries if it is not avoided.



NOTE!

This symbol in conjunction with the signal word indicates a potentially dangerous situation, which may lead to property or environmental damage if it is not avoided.

General safety instructions



Warning: incorrect use

The mechanical testing performed on all Giesse products in accordance with the European standards for the industry guarantee the safety of the movement and fastening systems. The wear resistance test and abuse tests on the hardware check their behaviour during their life cycle and verify their resistance in situations of involuntary abuse by the user.

In order to prevent personal injury or damage to accessories due to unintentional misuse, the following guidelines are provided:

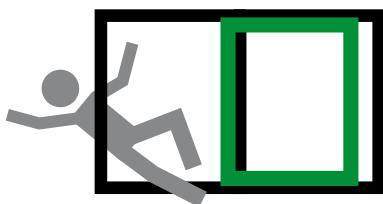

Danger of injury from falling through open windows.

- ✓ Act with care near to open windows.
- ✓ Keep children and people who cannot estimate the dangers away from the point of danger.

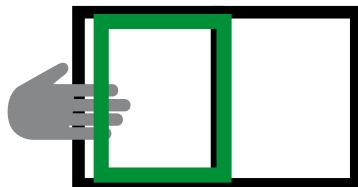

Danger of injury through trapping of body parts in the opening gap between sash and frame.

- ✓ When closing windows, never reach between sash and frame, and always act with care.
- ✓ Keep children and people who cannot estimate the dangers away from the point of danger.

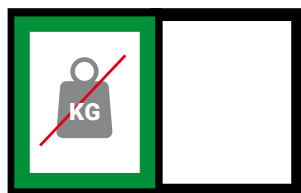

Danger of injury and material damage from overloading the sash.

- ✓ Do not overload the sash or the handle.

General safety instructions

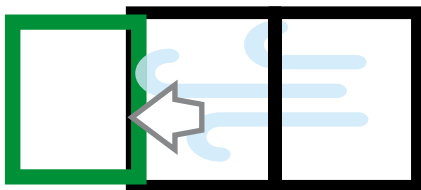

Danger of injury from the effect of wind.

- ✓ Do not leave the sash open in strong winds; in strong winds, sashes not properly secured in the open or closed position will slam, subjecting the hardware to mechanical stress and wear. Use appropriate catches or stoppers when opening.
- ✓ The sash could hit people near the window.

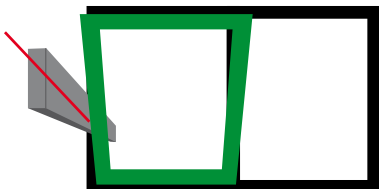

Danger of injury and material damage from insertion of obstructions into the opening gap between sash and frame.

- ✓ Do not insert objects into the opening gap between sash and frame.

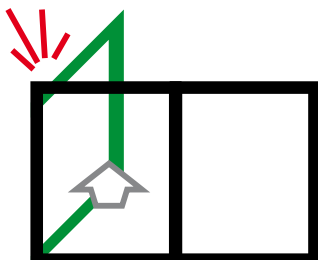

Danger of injury and material damage from pressing the sash against the opening edge (reveal).

- Do not press the sash against the opening edge (reveal).

Side-hung inward-opening: Tilt-and-turn opening hardware

Instructions for the end user

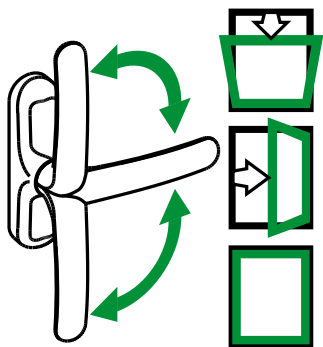

Tilt-and-turn operation

Handle at 180°

Sash in bottom-hung position. It is possible to open the window partially to ventilate the room moderately.

Handle at 90°

Sash in open position. The sash can be fully opened.

handle at 0°

Sash closed.

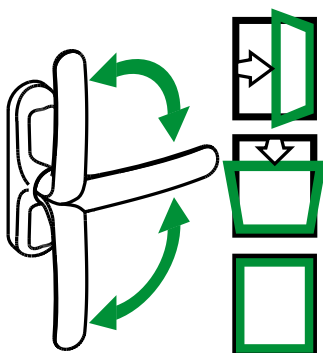

Logica Tilt-and-turn operation

Handle at 180°

Sash in open position. The sash can be fully opened.

Handle at 90°

Sash in bottom-hung position. It is possible to open the window partially to ventilate the room moderately.

handle at 0°

Sash closed.



If for some reason the upper hinge (arm) is released while the sash should be in side-hung or closed position, try this:

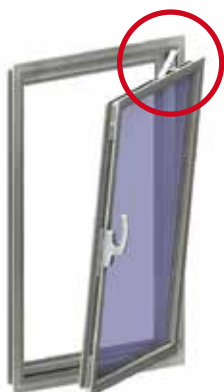

1

Keep the upper part of the sash slightly ajar from the frame.

2

Press the "incorrect movement" mechanism. (toggle near the handle/ cremone)

Simultaneously bring the handle into the side-hung open position (horizontal handle).



3

Release the "incorrect movement" mechanism.



4

Push the sash back into the frame and close it by turning the handle into the closed position (0°)



In the event that you do not feel confident in performing this manoeuvre, please contact the qualified personnel/installer

Side-hung inward-opening: Pivoting Window Opening Hardware

Instructions for the end user

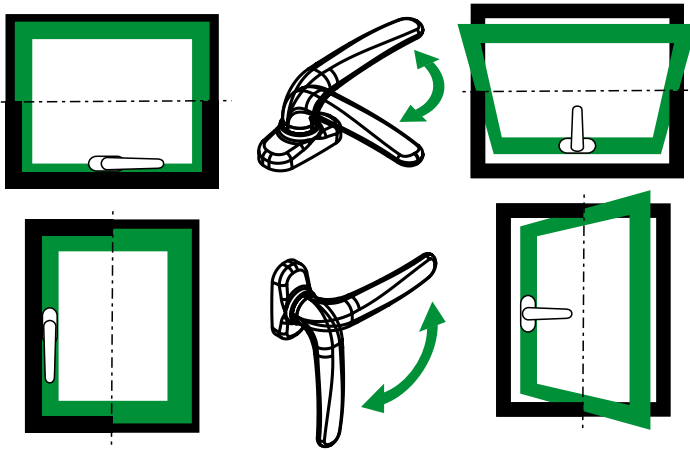
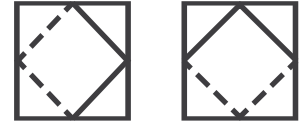

Handle at 0°

Closed position that is when ventilation is not required and when away from the premises.

Handle at 90°

Only for short but intense air ventilation or for cleaning the window. Do not leave the window unattended. For managing the 30° opening with block or 180° with no block, please refer to the fitting instructions provided with the Giesse pivot hinges.

Outward opening: Outward Opening Hardware

Instructions for the end user

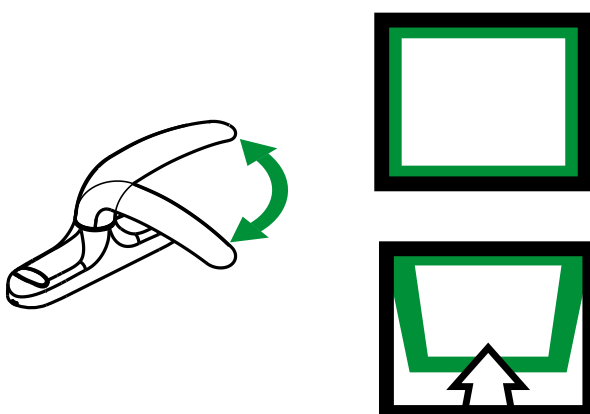
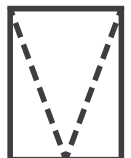

Handle at 0°

Sash closed.

handle at 90°

Sash in open position. The sash can be opened outwards.

Sliding opening: Lift-and-slide hardware

Instructions for the end user

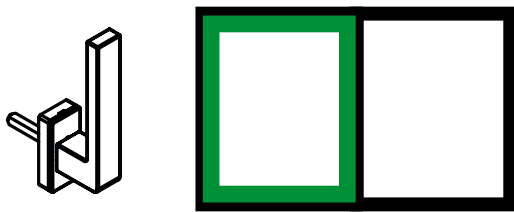
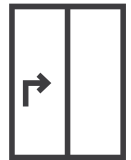

Handle at 180°

Sash closed. Never move the sash when the handle is in the closed position; this could cause damage to the closing seals.

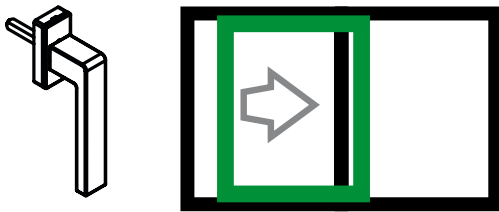

Handle at 0°

Sash in open position. The sash raises and you can open it by sliding it in the opposite direction to the cremone.

Sliding opening: Mechanisms for sliding systems

Instructions for the end user

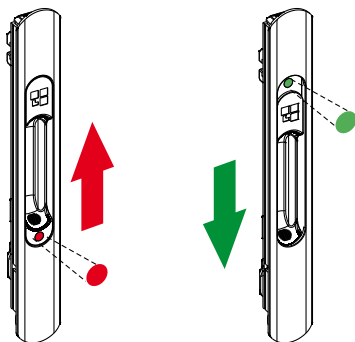
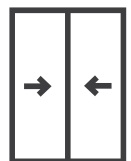

Handle with automatic closure

The handle is designed for automatic closure (nib automatically locks when the sash is closed). The nylon slider has two green and red surfaces that indicate respectively sash open and sash closed.



Handle with manual closure

Set the handle in the open position before half-closing the sash, to prevent the nib from improperly hitting the frame.

Side-hung inward-opening: Tilt-and-slide opening hardware

Instructions for the end user

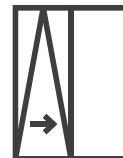

GS1000 - HD

SEMI-AUTOMATIC CATCH:

Do not accompany the sash when opening or closing.

GS1000 - HL-ML

MANUAL CATCH:

Pull the sash towards yourself when opening and manually push it when closing.

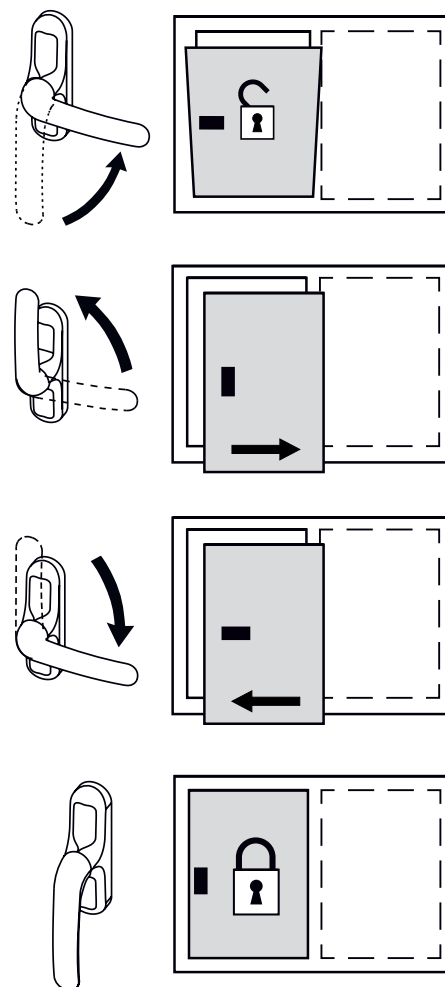
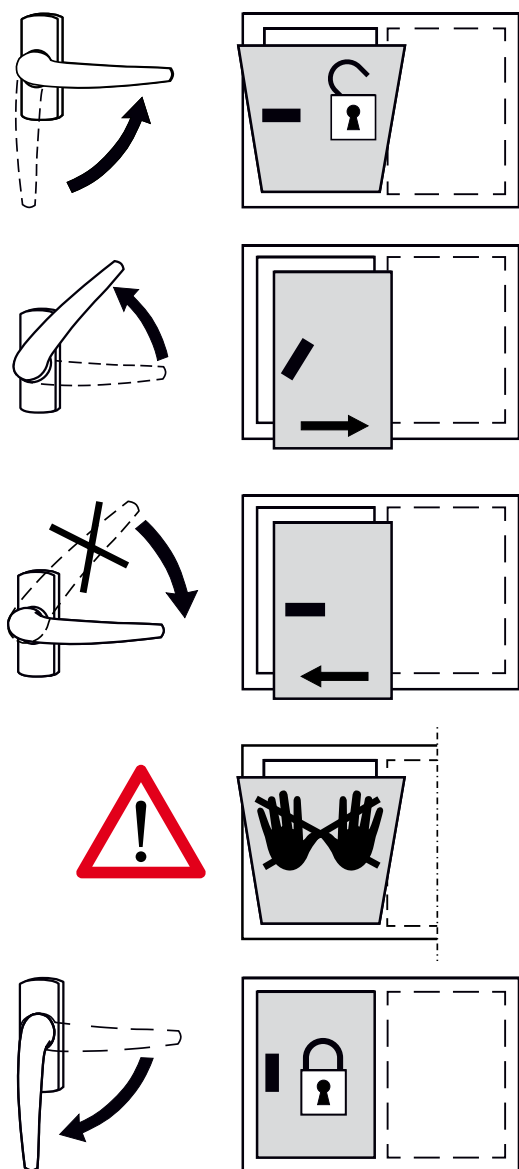

Door Hardware

Instructions for the end user

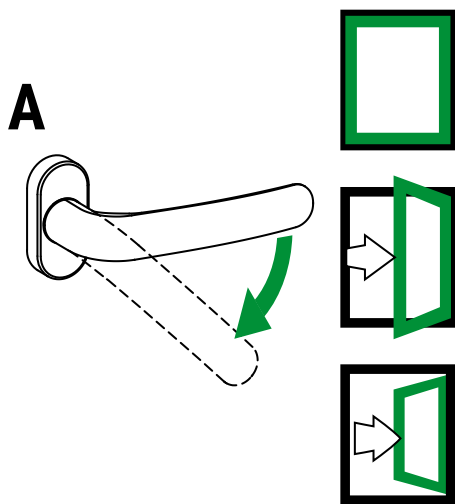

To open the single-sash door

1. Unlock any locks there may be
2. Push the handle downwards and pull the sash towards yourself (in the case of inward opening) or push it (in the case of outward opening).

To close the door, leave the handle in its original horizontal position and pull or push the door until it closes. If necessary, lock any locks.

- The handles are to be operated only in the direction indicated by the arrow and only until the end position is reached. If you use the handle in the opposite direction, it may damage the mechanism.
- Loading weights directly on the sash can cause damage, warping or sagging of the components.
- Loading weights on the handle can cause damage to the internal mechanism.

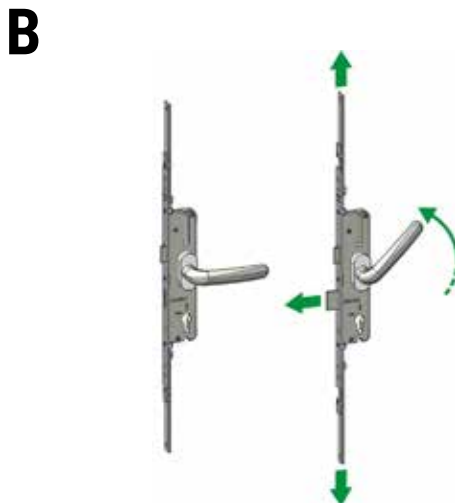

In the case of multipoint locks type 04645, to open the door you need to unlock the locking points by raising the handle to 135°.

Periodic cleaning of hardware

Clean all the moving parts of the hardware and all the fastening mechanisms regularly. Do not use aggressive cleaning products as these may compromise the protective treatments of the hardware, simply use neutral soap and water.

All the hardware components have received a surface treatment to prevent them from corroding. Accelerated tests in special climatic chambers verify the performance of these treatments, but performance of surface treatments cannot be assured without regular preventative cleaning and treatment of surfaces.

The accumulation of contaminants on the components, combining with water, can ruin the surface finish.

To maintain the quality of the surface of the hardware over time and to prevent deterioration due to corrosion, it is essential to observe the following:

- ✓ The hardware and the cavity between frame and sash are to be ventilated sufficiently, particularly during the construction phase, so as to avoid their direct exposure to moisture and the formation of condensation.
- ✓ The hardware must be protected against deposits and splashes of building materials (e.g. site dust, plaster mortar, concrete, etc.).
- ✓ The aggressive vapours in the cavity between sash and frame are in contact (due, e.g., to formic or acetic acid, ammonia, amine or ammonia compounds, aldehyde, phenol, tannic acid, etc.) in combination with condensation can cause rapid corrosion of the mechanisms. When there are these aggressive vapours, it is necessary to provide sufficient ventilation for the area of the rebate of windows and balcony-doors.
- ✓ It is not permissible to use acid or acetic cured sealants, or sealants containing the substances mentioned above, because the surface can get damaged both by direct contact with the sealant and by the fumes from this material.
- ✓ Clean all exposed parts or surfaces to prevent dirt from being able to build up. Particularly for external hardware and hardware regularly exposed to the elements, you can remove any acid deposits from smog, acid rain, etc., preventing oxidation and corrosion of the parts and mechanisms for moving the sashes.

If there are any scratches or other damage on the surface, its protection against corrosion is no longer guaranteed, so be aware:

- ✓ do not use aggressive or corrosive cleaning products, solvents or detergents, such as synthetic thinners, acetone or nitro thinners; do not use any products whose makeup is unknown, and do not use solvent based detergents and polishers.
- ✓ Refer to the product labels before use to ensure that they are compliant.
- ✓ do not use any abrasive substances.
- ✓ do not use any hard materials such as scrapers, metal brushes, rough sponges, etc.

In the case of sliding windows, clean the sash runners frequently, removing the dust, sand, salt, etc., which may hinder the smooth sliding of the pulleys.

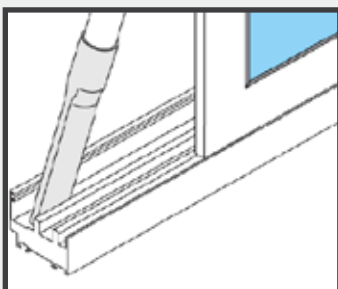

For GOS-S windows, in order to enable excellent drainage of the water, periodically clean or vacuum the area by the T-REX water evacuation plug.



Specific instructions for Maintenance by type of opening

The following information on product use should be taken as indicative, the official GIESSE instruction sheets and technical information sheets are an integral part of the specifications for product use.

Maintenance instructions for specialists

TILT-AND-TURN WINDOW HARDWARE

For the maintenance frequency please refer to the frequency table at the end of this manual.

Avoid removing any hardware during normal use or during cleaning and maintenance operations.

- ✓ Check that the force for turning the handle is not significantly greater than when the window was first put into use or excessive compared to normal use. To avoid inadvertent damage, never force the hardware. After checking that the accommodating holes are free of impediments (materials, dust, insects), evaluate the need for replacements only after contacting the installer.
- ✓ Lubricate all metal parts that slide on top of each other using technical Vaseline grease, Teflon grease spray or chain grease; in particular, proceed on the sliding components of the opening mechanism: corner joints, scissor and opening-limiting arms, bottom hinges for tilt and turn and locking devices.
- ✓ To unlock movements use specific unlocking products, then clean and lubricate thoroughly with grease as mentioned above.

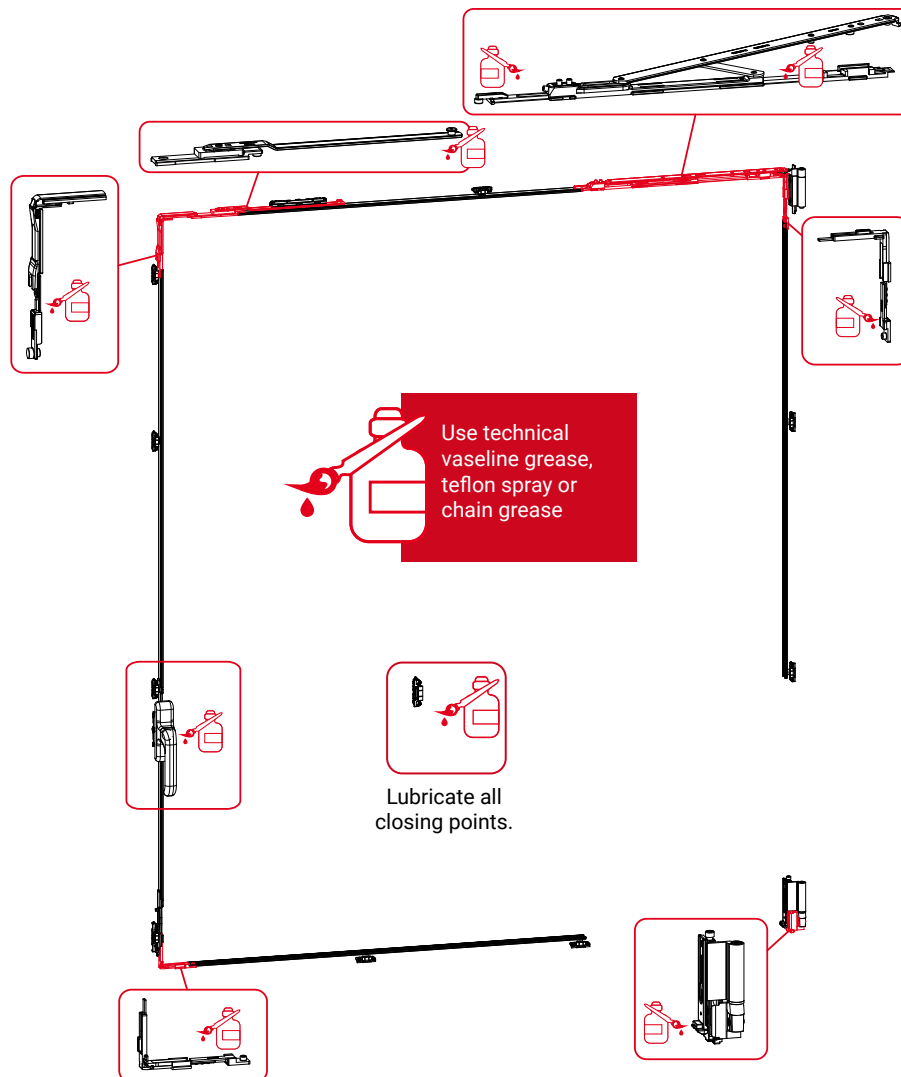

The fitting instructions are available on the Giesse website www.tyman-international.com, for more information contact infotechgiesse@tyman.com

Maintenance instructions for specialists

C.H.I.C. TILT-AND-TURN WINDOW HARDWARE

For the maintenance frequency please refer to the frequency table at the end of this manual.

Avoid removing any hardware during normal use or during cleaning and maintenance operations.

- ✓ Check that the force for turning the handle is not significantly greater than when the window was first put into use or excessive compared to normal use. To avoid inadvertent damage, never force the hardware. After checking that the accommodating holes are free of impediments (materials, dust, insects), evaluate the need for replacements only after contacting the installer.
- ✓ Lubricate all metal parts that slide on top of each other using technical Vaseline grease, Teflon grease spray or chain grease; in particular, proceed on the sliding components of the opening mechanism: corner joints, scissor and opening-limiting arms, bottom hinges for tilt and turn and locking devices. For lubricating CHIC hinges, use lithium grease such as Kemper grease HT.
- ✓ To unlock movements use specific unlocking products, then clean and lubricate thoroughly with grease as mentioned above.

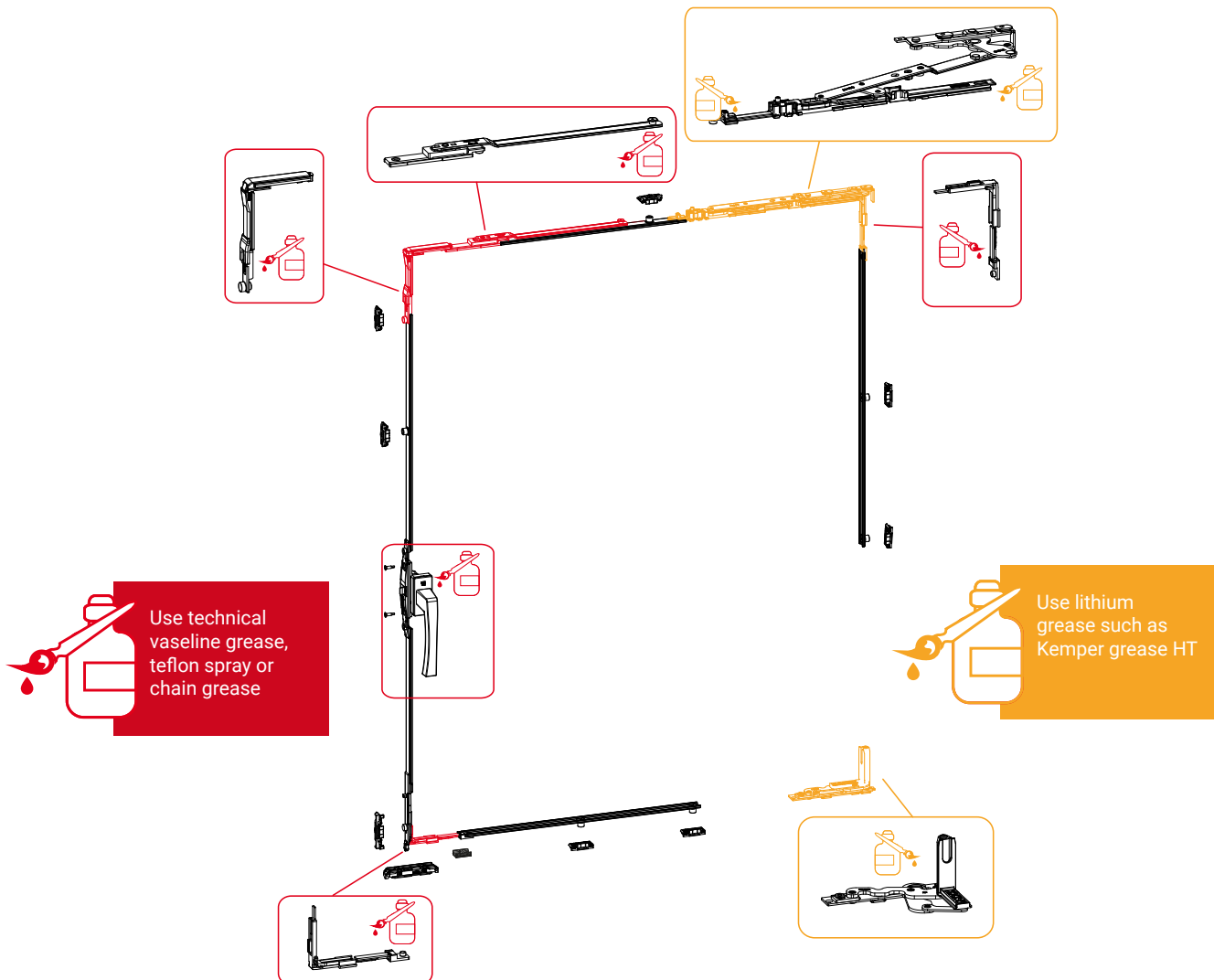

The fitting instructions are available on the Giesse website www.tyman-international.com, for more information contact infotechgiesse@tyman.com

Maintenance instructions for specialists

PIVOTING WINDOW HARDWARE

For the maintenance frequency please refer to the frequency table at the end of this manual.

Avoid removing any hardware during normal use or during cleaning and maintenance operations.

- ✓ Check that the force for turning the handle is not significantly greater than when the window was first put into use or excessive compared to normal use. To avoid inadvertent damage, never force the hardware. After checking that the accommodating holes are free of impediments (materials, dust, insects), evaluate the need for replacements only after contacting the installer.
- ✓ Check the friction on opening and closing the sash and, if it is excessive, contact a specialized window-maker for the adjustment.
- ✓ Lubricate all metal parts that slide on top of each other using technical Vaseline grease, Teflon grease spray or chain grease; in particular, proceed on the sliding components of the opening mechanism: corner joints.
- ✓ To unlock movements use specific unlocking products, then clean and lubricate thoroughly with grease as mentioned above.

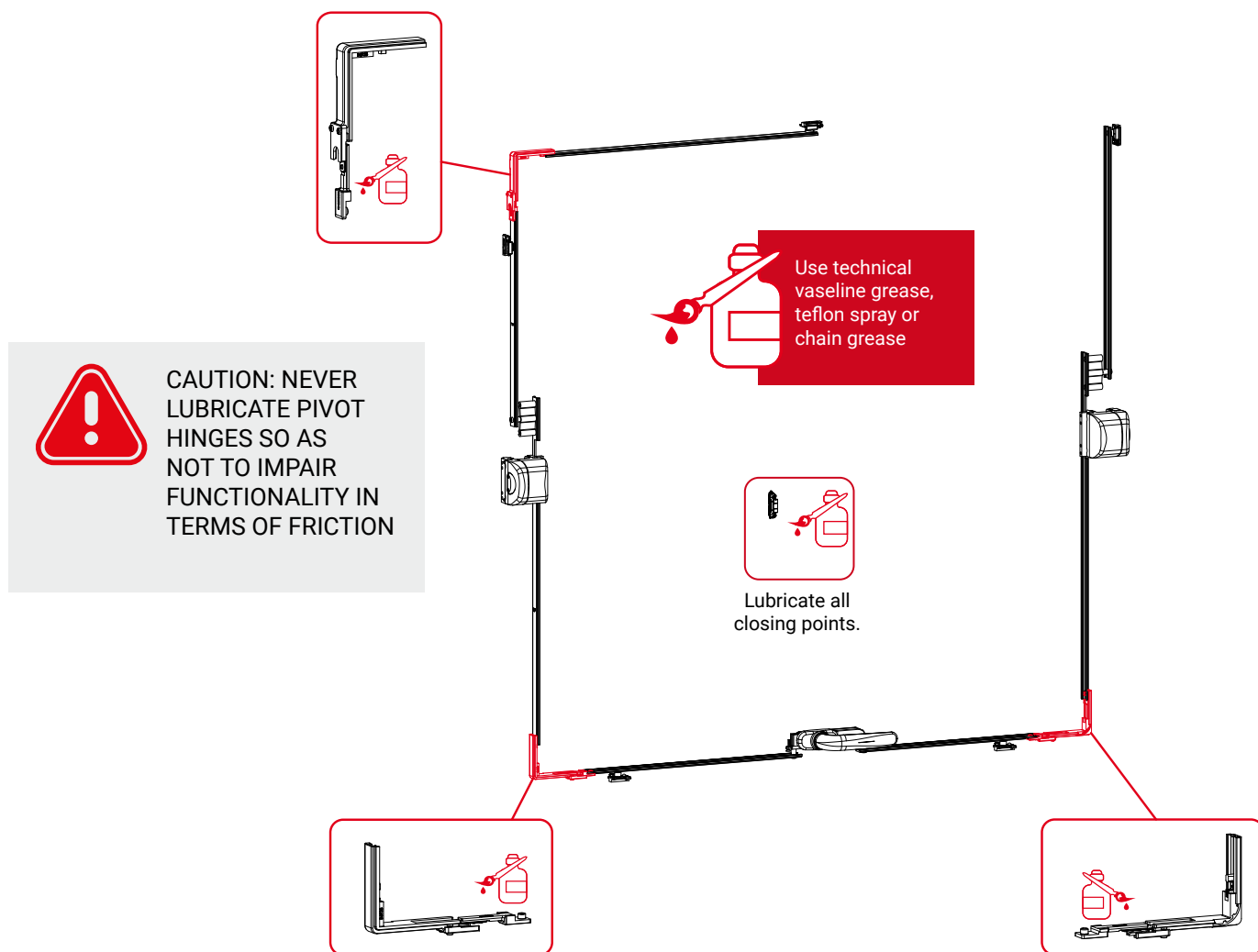

The fitting instructions are available on the Giesse website www.tyman-international.com, for more information contact infotechgiesse@tyman.com

Maintenance instructions for specialists

OUTWARD OPENING HARDWARE

For the maintenance frequency please refer to the frequency table at the end of this manual.

Avoid removing any hardware during normal use or during cleaning and maintenance operations.

- ✓ Check that the force for turning the handle is not significantly greater than when the window was first put into use or excessive compared to normal use. To avoid inadvertent damage, never force the hardware. After checking that the accommodating holes are free of impediments (materials, dust, insects), evaluate the need for replacements only after contacting the installer.
- ✓ Lubricate all metal parts that slide on top of each other using technical Vaseline grease, Teflon grease spray or chain grease; in particular, proceed on the sliding components of the opening mechanism: corner joints, scissor and opening arms.
- ✓ To unlock movements use specific unlocking products, then clean and lubricate thoroughly with grease as mentioned above.

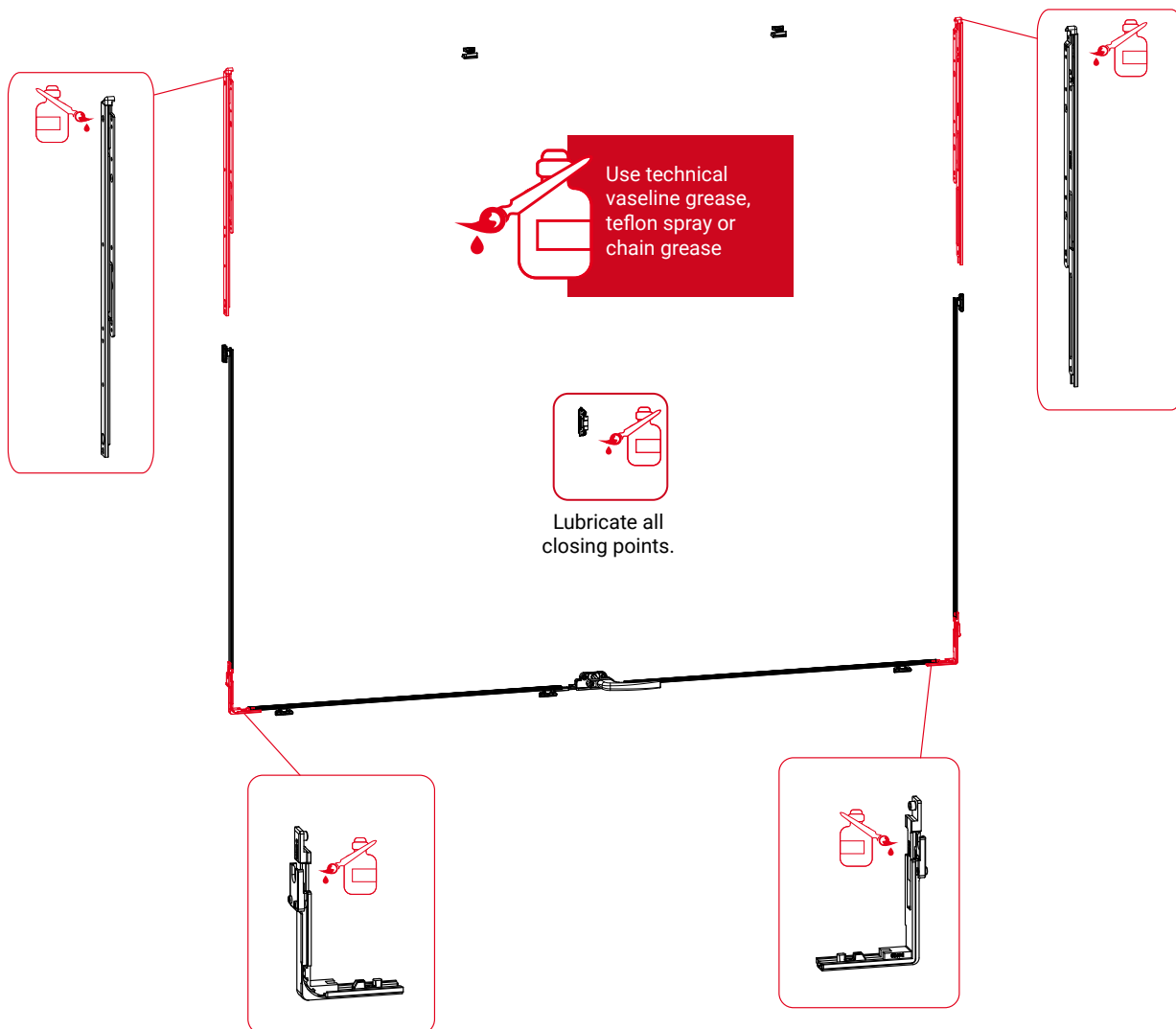

The fitting instructions are available on the Giesse website www.tyman-international.com, for more information contact infotechgiesse@tyman.com

Maintenance instructions for specialists

LIFT-AND-SLIDE HARDWARE

For the maintenance frequency please refer to the frequency table at the end of this manual.

Avoid removing any hardware during normal use or during cleaning and maintenance operations. If there are any issues related to one of the points mentioned below that are not resolved by thoroughly cleaning the guides and greasing the sliding components, you need to call in the installer.

- ✓ Check that the force for turning the handle is not significantly higher than that for normal use
- ✓ Check that, in the closed position, the sash lowers without any obstructions and smoothly throughout the envisaged travel
- ✓ The sashes must slide without any obstructions or excessive friction
- ✓ Lubricate the carriages with specific commercially available products.
- ✓ Adjustment: see fitting instructions.

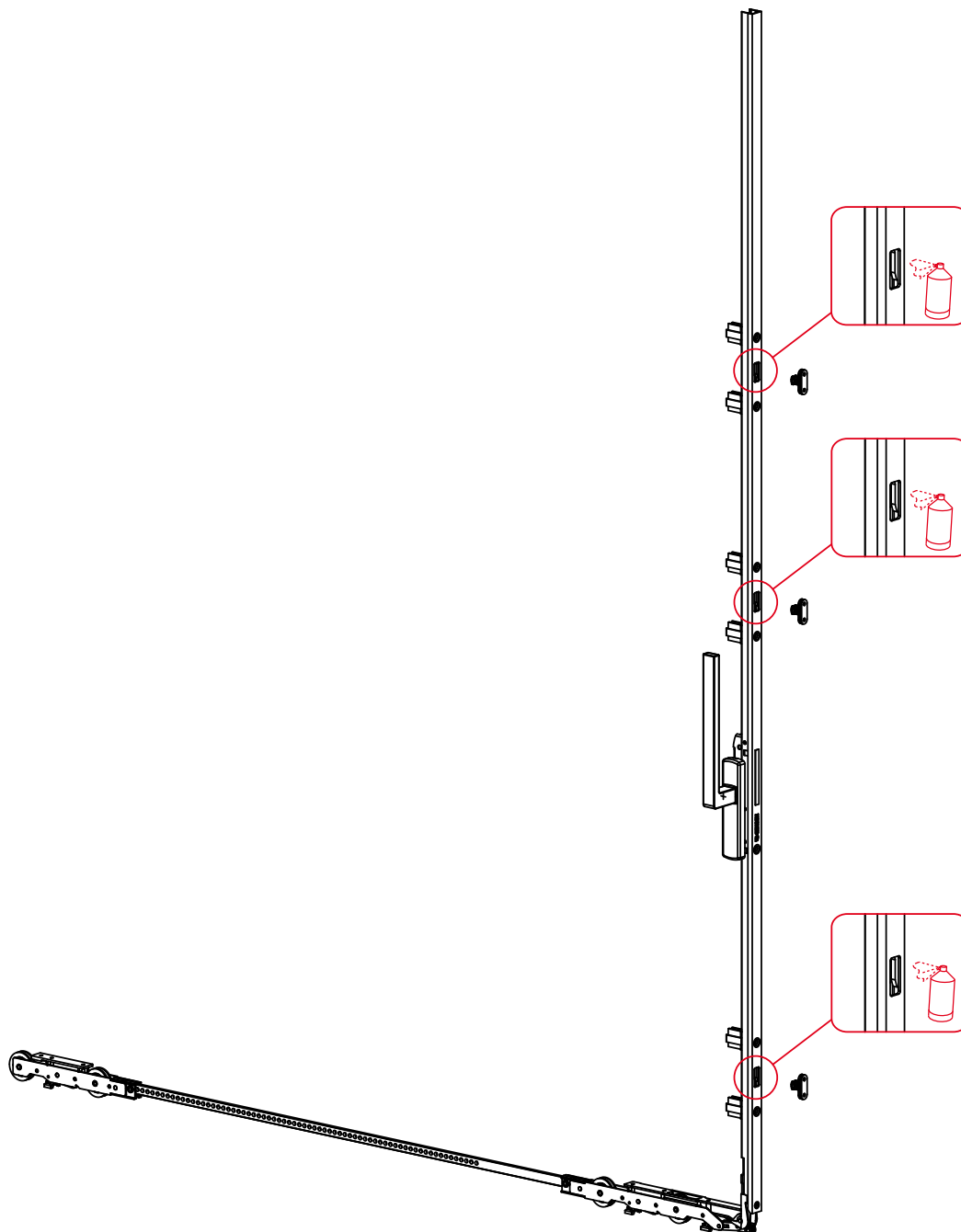

The fitting instructions are available on the Giesse website www.tyman-international.com, for more information contact infotechgiesse@tyman.com

Maintenance instructions for specialists

SLIDING HARDWARE

For the maintenance frequency please refer to the frequency table at the end of this manual.

Avoid removing any hardware during normal use or during cleaning and maintenance operations. If there are any issues related to one of the points mentioned below that are not resolved by thoroughly cleaning the guides and greasing the sliding components, you need to call in the installer.

- ✓ Check that the force for moving the handle is not significantly higher than normal use and that the automatic mechanism for closing the handle functions unimpeded
- ✓ Check the position of the nib with respect to the counterplate and then tighten the screw if necessary
- ✓ Lubricate the carriages with specific commercially available products, the sashes must slide without hindrance or excessive friction.

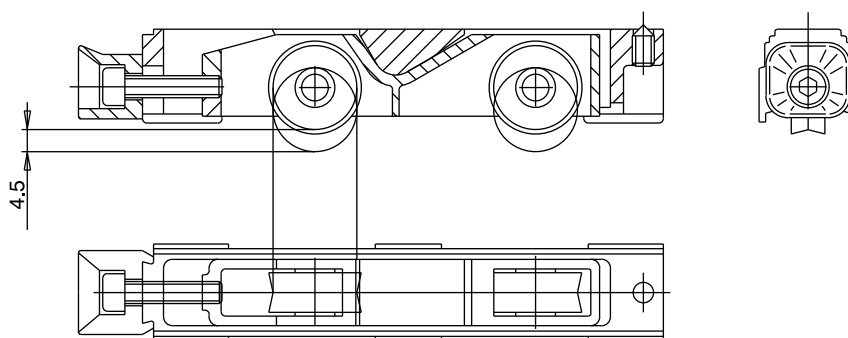

The fitting instructions are available on the Giesse website www.tyman-international.com, for more information contact infotechgiesse@tyman.com

Maintenance instructions for specialists

TILT-AND-SLIDE HARDWARE

For the maintenance frequency please refer to the frequency table at the end of this manual.

Avoid removing any hardware during normal use or during cleaning and maintenance operations. If there are any issues related to one of the points mentioned below that are not resolved by thoroughly cleaning the guides and greasing the sliding components, you need to call in the installer.

- ✓ Check that the force for turning the handle is not significantly higher than that for normal use
- ✓ Check that, in the closed position, the sash enters without any obstructions and smoothly throughout the envisaged travel
- ✓ The sashes must slide without any obstructions or excessive friction
- ✓ Lubricate the carriages and moving parts (see following graphic) with specific commercially available products.

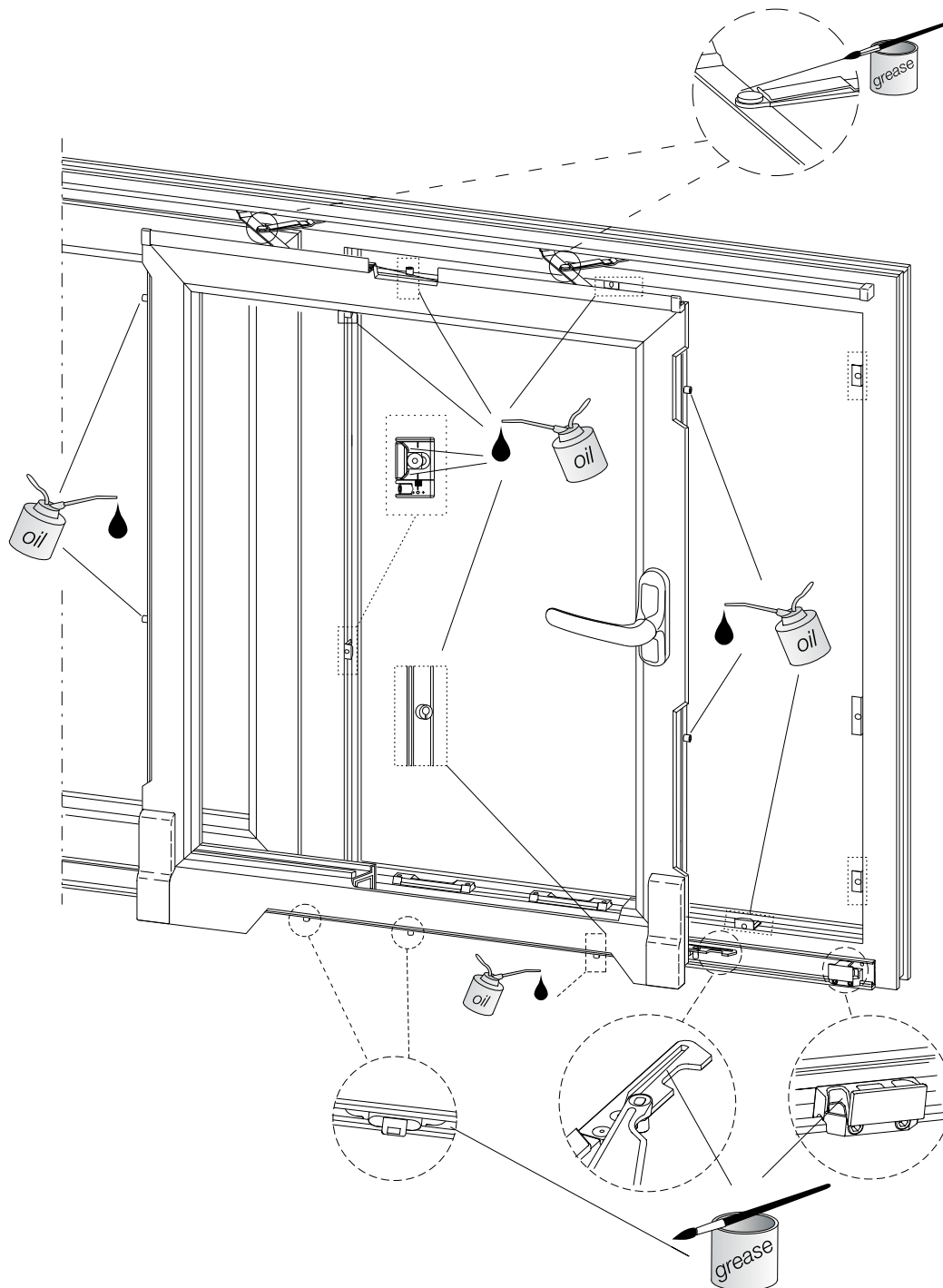

Maintenance instructions for specialists

DOOR HARDWARE

For the maintenance frequency please refer to the frequency table at the end of this manual

HINGES

Check that the force for turning the door is not significantly greater than when the door was first put into use or excessive compared to normal use. If there are any defects in opening and/or closing never strain the movement in order to avoid sudden breakage.

Check that the hinge fixing screws are properly tightened on both the frame side and on the sash side; if necessary tighten within the tightening torque limits.

Check for any problems of misalignment of the sash or its rubbing on the floor; use the hinge adjustment systems as indicated in the fitting instructions for the product.

CYLINDERS

As for the cylinders, it is advisable to perform periodic lubrication with graphite powder at the first occurrence of slight sticking when inserting and removing the key from the cylinder. Do not use lubricant oils because they could accumulate deposits of dust and impair the internal mechanism of the cylinder.

LOCKS

- a. With the door open, operate the lock, both with the handle and with the cylinder, to make sure that operation is smooth and trouble-free.
- b. Check that the counterplate (striker) is firmly fixed to the frame, close the door again and check that it has the proper clearance from the frame (correct compression of the seals). If you detect any trouble, caused by the settling of the door, adjust the counterplate (i.e. the position of the counterplate if it is a non-adjustable version).
- c. Inspect the lock, make sure that the screws fastening it to the profile are tightened, as well as the screw that secures the cylinder. Operate the lock both with the handle and with the cylinder to make sure that operation is smooth and trouble-free.
- d. Open and close the door and check that the opening and closing mechanisms are smooth and in a satisfactory condition. If necessary, to eliminate any slack due to the settling of the door, adjust the position of the counterplate (see point b) above.
- e. Lubricate the spring latch/counterplate contact zones and, lubricate the mechanism inside the lock through the holes for the spring latch and bolt. Use only spray lubricants with PTFE additives that are declared by the manufacturer to be fit for the purpose.

Hardware maintenance frequency table

The maintenance frequency depends on the environment around the building and must be higher near the coast, in industrial areas, and in heavily polluted areas.

The following maintenance intervals are recommended in relation to the installation conditions:

EXTERNAL ENVIRONMENT	MAINTENANCE FREQUENCY
RURAL NOT POLLUTED	EVERY YEAR
NORMAL URBAN AND INDUSTRIAL	EVERY YEAR
HARSH URBAN AND INDUSTRIAL	EVERY SIX MONTHS
MARINE FROM 1 TO 20 KM	EVERY SIX MONTHS
MARINE FROM 0 TO 1 KM	EVERY THREE MONTHS

Table 1

Normal rural, urban or industrial environment

Conditions corresponding to the outside of buildings located in a rural area, without any specific pollution consisting in particular in the emission of sulphurous fumes (diesel heating).

Conditions corresponding to the outside of buildings located in areas occupied by urban agglomerations and/or in an industrial environment comprising one or more factories that emit gases and fumes that cause a considerable increase in air pollution, without, however, being a source of corrosion related to a high concentration of chemical compounds.

Heavy duty urban and industrial conditions

Conditions corresponding to the outside of buildings located in areas occupied by urban agglomerations and/or in an industrial environment with a high concentration of chemical compounds that are a source of corrosion (industrial environment comprising, in particular, refineries, incinerators, distilleries, cement plants, paper mills) continuously or intermittently.

Marine conditions

Conditions corresponding to the exterior of buildings located from 1 to 20 km from the coast. In coastal areas where severe wave action and onshore winds are prevalent, maintenance should be conducted as per our coastal conditions below, up to a distance of 3-5km from the coast.

Marine conditions (coastal)

Located from 0 to 1 km from the coast, in which sea water, transported as an aerosol, comes into partial or temporary contact with buildings constructed, in whole or in part, with the products; areas in which sprays of sea water come directly into contact with buildings constructed, in part or in whole, with the products.

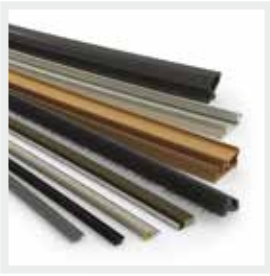

Schlegel

High performance sealing solutions



GIESSE

Innovative engineered hardware



REGUITTI

Italian design handles



JATEC

Timeless exclusive handles

